TB8100 base station

Service Kit User's Manual



MB8100-00-00-806
March 2004

Contents

Preface	vii
Enquiries and Comments	vii
Updates of Manual and Equipment	vii
Copyright	vii
Disclaimer	vii
Typographical Conventions	vii
Associated Documentation	vii
Publication Record	viii
Introduction	1
From T800 to TB8100	3
Operation Modes	4
Channels	5
Profiles	6
Subaudible Signalling	7
Power Saving	8
Task Manager	9
Modifying Task Manager	9
Tasks and Comments	10
Inputs	10
Actions	10
Custom Inputs and Actions	11
Remote Connections	12
Alarms	13
Alarm Notification Options	13
Enabling Alarm Notification	13
System Interface	14
Software Feature Enabler	15
Getting Started	17
Connecting and Logging On	19
Monitoring Alarms	20
Monitoring the Base Station	21
Viewing Configuration Settings	22
Diagnosing Problems	23
Configuration Tutorial	24
Step 1: Install the Service Kit and Calibration Kit on your PC	24
Step 2: Connect and Log On	24
Step 3: Read the Base Station's Configuration	25
Step 4: Configure the Base Station as a Talk-Through Repeater	25
Step 5: Configure a Channel	27
Step 6: Set the Default Channel.	27
Step 7: Program the Changes into the Base Station	27
Basic Tasks	29
Using the Service Kit	31
Toolbar	31
Status Bar	32
Setting Service Kit Options	33
Setting Up and Configuring Connections	34

Adding a Connection	34
Adding a Direct Connection	34
Adding a Modem Dialup Connection	35
Adding an Over-the-Air Connection	36
Editing a Connection	37
Connecting to a Base Station System	38
Logging On to a Base Station	39
Base Station Table	39
Logon Details	40
Changing Base Station Mode	41
Resetting the Base Station	41
Working With Base Station Configurations	42
Creating a New Configuration	43
Reading a Configuration	43
Saving a Configuration	44
Programming a Base Station	44
Creating a Configuration Template	45
Changing Base Station Passwords	46
Access Profiles	47
Viewing an Access Profile	47
Modifying Access Profiles	48
Logging Off and Disconnecting	49
Working with Different Versions	50
Service Kit Handling of Older Versions	51
Upgrading Base Station Firmware	52
Working with the Software Feature Enabler	54
Enabling Additional Features	54
Disabling a Feature Set	55
Disabling the Alarm Reporting Feature Set	55
Disabling the Advance Profiles and Task Manager Feature Set	55
Disabling the Power Saving Modes Feature Set	56
Disabling the Default Radio System Feature Set	56

Monitoring 57

Module Details	59
Viewing Reciter Information	59
Versions	60
Viewing Power Amplifier Information	60
Versions	61
Viewing Power Management Unit Information	61
Inputs	62
Outputs	62
Versions	62
Operational Information	63
Monitoring the Current Channel	63
Current Channel	63
Profile Information	63
Current Source	64
Monitoring the Reciter	65
Monitoring the Power Amplifier	66
Monitoring the Power Management Unit	67
Viewing System Data	70
Base Station Data	70
Power Amplifier Data	71

Power Management Unit Data	71
Configuring the Base Station	73
Choosing a Configuration	75
Configuring General Options	76
Configuring the System Interface	77
Viewing System Interface Details	77
Configuring External Channel Selection	77
Configuring RSSI Output	78
Converting Between Microvolts and dBm	80
Configuring Fan Control	81
PA Fan Control	81
Emulating T800 Fan Operation	81
Fans	82
Configuring Miscellaneous Items	83
Tx relay operation	83
Minimum battery voltage	84
Auxiliary power control	84
CTCSS characteristics	85
Reverting to Run mode	85
Select external clock reference frequency (if fitted)	85
Printing a Base Station Configuration	86
Configuring Channels	87
Getting Started with Channels	89
Customizing the Default Channel Profile	90
Customizing the Default Signalling Profile	92
Using Advanced Profile Features	93
Working with Channel Profiles	94
Adding a Channel Profile	94
Configuring Receiver Gating	96
Configuring Power Saving	96
Editing a Channel Profile	97
General	98
Signal Path	103
Power Saving	109
CWID System	110
Task Manager	111
Working with Signalling Profiles	112
Adding a Signalling Profile	112
Setting Up a Reminder Tone	114
Editing a Signalling Profile	115
Subaudible Signalling	115
Tx Timers	118
Advanced	120
Task Manager	121
Working With the Channel Table	122
Channel Table Details	122
Columns	122
Buttons	124
Editing a Channel (Default Profiles)	125
Editing a Channel (Custom Profiles)	125
Adding and Copying Channels	126
Block Copying Channels	126

Importing Channels	127
Exporting Channels	127
Selecting a Channel	128
Printing Channel Data	129

Alarms 131

Monitoring Alarms	133
Reciter	134
Power Amplifier	135
System	137
Power Management Unit	139
Viewing Recent Alarms	141
Disabling Unwanted Alarms	142
Altering Alarm Thresholds	143
Notifying Alarms	145
Notifying Over the Air	145
Notifying Over the Line	146
Configuring Alarm Center Communications	147
Configuring Email Messaging	149

Diagnosing 151

Carrying Out Diagnostic Tests	153
System Tests	154
Self-Tests	154
Control Panel Tests	155
Reciter Tests	156
Receiver Tests	156
Testing Receiver Operation	156
Testing Receiver Sensitivity	157
Measuring Received Signal Levels	157
Determining Synthesiser Lock Ranges	158
Audio I/O Tests	159
Measuring the Audio Input Level	159
Generating an Audio Output	160
Digital I/O Tests	160
Testing Digital Outputs	161
Testing Digital Inputs	161
Testing Hardware Channel Selection	162
Miscellaneous Tests	162
RSSI Tests	162
Sending a Test Email	163
Detecting Subaudible Signalling	164
Power Amplifier Tests	165
Control Tests	165
Testing the PA Fault LED	165
Testing the Fan	166
Testing the Transmitter	166
Power Management Unit Tests	169
Control Tests	169
Simulating Mains Failure	169
Testing the Fan	169
Testing the PMU fault LED	170
Testing the Auxiliary Power Output	170
Viewing Additional Details	171

Task Manager	173
Accessing Task Manager	175
Working With Task Manager	176
Maintaining the Task List	176
Adding a Task	177
Adding a Comment	178
Disabling a Task	178
Importing Tasks	179
Exporting Tasks	179
Task Manager Inputs and Actions	180
Inputs	180
General Inputs	180
Channel Profile Inputs	183
Signalling Profile Inputs	185
System I/O	185
Alarm Inputs	186
Custom Inputs	189
Actions	189
General Actions	190
Channel Profile Actions	193
Signalling Profile Actions	195
System I/O	196
Alarm	197
Custom Actions	198
Task Manager Examples	199
Repeater Changeover	199
Data and Speech Service	199
Base Station with Automatic Charging	200
Base Station with Auxiliary Antenna	201
Base Station Regularly Emails its Status	201
Base Station that Controls Landing Lights	201
Scanning Repeater	202
Digital Inputs with Special Functions	202
Subtone Decode Disable Pin	202
Cancel Alarms Pin	202
Customizing Task Manager	203
Working With Custom Inputs	203
Viewing a Custom Input	203
Defining a Custom Input	204
Working With Custom Actions	204
Viewing a Custom Action	205
Defining a Custom Action	205
Defining Counters, Timers, and Flags	205
Monitoring Task Manager	206
Viewing System Flag States	206
Monitoring Recent Actions	208
Viewing Timers	208
Viewing Counters	208
Viewing Flag States	208
Glossary	209
Index	219

Preface

Welcome to the TB8100 Service Kit User's Manual. This manual provides you with information about the Tait TB8100 Service Kit in PDF format. You can view it online or print it if you want a paper copy. It describes how to use Version 02.00 of the Service Kit.

- New Service Kit users should begin at Part B: Getting Started.
- For explanations of essential concepts, look in Part A: Introduction.
- The rest of the manual assumes that you are familiar with Part C: Basic Tasks.

Enquiries and Comments

Any enquiries regarding this manual as well as any comments, suggestions and notifications of errors, should be addressed to support@taitworld.com or to the Support Group Manager, Tait Electronics Limited, PO Box 1645 Christchurch, New Zealand.

Updates of Manual and Equipment

In the interests of improving the performance, reliability, or servicing of the equipment, Tait Electronics Limited reserves the right to update the equipment or this manual or both without prior notice.

Copyright

All information contained in this and other TB8100 manuals is the property of Tait Electronics Limited. All rights are reserved. These manuals may not, in whole or in part, be copied, photocopied, reproduced, translated, stored, or reduced to any electronic medium or machine-readable form, without prior written permission from Tait Electronics Limited. All trade names referenced are the service mark, trademark, or registered trademark of the respective manufacturers.

Disclaimer

There are no warranties extended or granted by these manuals. Tait Electronics Limited accepts no responsibility for damage arising from use of the information contained in the manuals or of the equipment and software it describes. It is the responsibility of the user to ensure that use of such information, equipment, and software complies with the laws, rules, and regulations of the applicable jurisdictions.

Typographical Conventions

'File > Open' means 'click File on the menu bar, then click Open on the list of commands that pops up'. 'Monitor > Module Details > Reciter' means 'click the Monitor icon on the toolbar, then in the navigation pane find the Module Details group, and select Reciter from it'.

Associated Documentation

All available TB8100 product documentation is provided on the CD supplied with the base station. Updates may be published on the Tait support web.

Online Help. The Service Kit also has online Help. It contains more or less the same information as this manual. To view it, start the Service Kit, then press F1 or click the Help icon on the toolbar. If you are in a dialog box, click the Help button. The Alarm Center and the Calibration Kit also have online Help.

TB8100 Installation Guide.

TB8100 Operation Manual.

TB8100 Service Manual. (service centers only)

TB8100 Product Catalog provides information about base station parts and modules.

Technical notes are published from time to time to describe applications for Tait products, to provide technical details not included in manuals, and to offer solutions for any problems that arise. Look for them on Tait's technical support website. The following have been published or are in development:

TN-742 Remotely Monitoring and Configuring the Tait TB8100.

TN-743 Using the TB8100 Base Station as a Talk-Through, Community, or Linked Repeater

TN-745 Using the Tait TB8100 in TaitNet Trunked Networks.

TN-744 Using the Tait TB8100 as a Line-Connected Base Station.

Publication Record

Version	Date	Description
1.00	June 2003	First release of the manual. Describes version 1.00 of the Tait TB8100 Service Kit software.
02.00	March 2004	Second release of the manual. Describes version 02.00 of the Service Kit.

Part A Introduction

The Service Kit is a Windows-based software program that makes it easy to monitor and configure a Tait [TB8100 base station](#). You can also use it to carry out diagnostic tests and update the base station's firmware.

The introduction explains concepts that are fundamental to the base station. You need to understand them before you can use the Service Kit effectively.

Topics

- [From T800 to TB8100](#)
- [Operation Modes](#)
- [Channels](#)
- [Profiles](#)
- [Subaudible Signalling](#)
- [Power Saving](#)
- [Task Manager](#)
- [Remote Connections](#)
- [Alarms](#)
- [System Interface](#)
- [Software Feature Enabler](#)

From T800 to TB8100

The TB8100 is a software-based radio. This means that its programming software has far more scope. For those who are familiar with the Tait PGM800Win programming software, here are some key differences.

- The Service Kit does more than configure channels. It can monitor operational details, receive alarms, log a user-defined set of parameters, and carry out diagnostic tests. It can switch the base station's operating mode from Run to Standby and back again and even reset the base station or upgrade its firmware. It also lets you edit Task Manager tasks, which enables you to customize the TB8100 for individual applications. See [“Task Manager” on page 9](#).
- The Service Kit can connect remotely to the base station via dial-up modems or radio modems. You can make routine monitoring checks and carry out diagnostic tests without needing to travel to the site.
- The [channel table](#) does more than define the transmit and receive frequencies and the frequency of the tone used for [CTCSS](#). It specifies a whole range of operational parameters. Because there are so many configurable parameters, most are grouped into profiles. There are two kinds of profiles: channel profiles and signalling profiles. See [“Profiles” on page 6](#).
- The Service Kit provides both a simple and a complex method for configuring the channel table. The simple way uses default profiles and lets you edit items directly in the table. The complex way is available if the base station has an Advanced Profiles and Task Manager license. You define a set of custom profiles then select the right ones for each channel.
- Custom profiles make it possible for you to assign up to 16 [subtones](#) to any channel, meaning that a tone panel is not needed for most applications.
- The Service Kit can configure signal paths. In effect this means that you can customize ‘virtual backplanes’. These are profile-based so that the base station can change its virtual backplane in the middle of operations. For example, a Task Manager action can change the base station from a line-connected base station to a talk through repeater, simply by changing to a channel with a different custom profile.

Operation Modes

A [base station](#) can operate in three different modes. Some functions are disabled until you shift the base station into the required mode.

- Run mode is used for normal operation.
- Standby mode is required if you want to program the base station or carry out diagnostic tests on it. Standby mode puts the base station out of service. However it will still transmit if you push the Carrier button on the control panel, use a microphone, or carry out a transmission test.
- Download mode is required if you want to update the base station's firmware. (The base station automatically enters Download mode if it has a fundamental problem.)

Appropriate messages alert you to the need to change mode so that you do not inadvertently leave the base station out of service when you end a Service Kit session. Alternatively, you can configure the base station to automatically revert from Standby to Run mode after the Service Kit logs off.

The Mode icon on the toolbar displays the current mode of the base station you are logged in to.



It is in the form of a traffic light:

- Green indicates Run mode
- Orange indicates Standby mode
- Red indicates Download mode

Click on it to change mode.

The status bar also displays the current mode.

Channels

A TB8100 base station consists of the equipment needed to operate on just one [channel](#). However, using the Service Kit you can program up to 255 channels into a single base station. This is confusing, until you realize that ‘channel’ has different meanings. The one channel is the transmit and receive frequency pair and the 255 channels are different channel configurations, each with its own number and name. You select one of these channel configurations and the base station operates according to all the settings defined by it. These include a transmit and receive frequency pair, a transmitter power output, a channel spacing, and many other configurable items.

Channel Table

Each base station has a [channel table](#). This is the database that stores the channel configurations. It is a good idea to maintain a single channel table for your system. This means that you can use almost the same [configuration file](#) for all base stations. To configure a new or replacement base station, all you need to do is copy the standard configuration file and select a different default channel. This simplifies maintenance. Alternatively, you can use the Export and Import functions to copy channels from one base station to another.

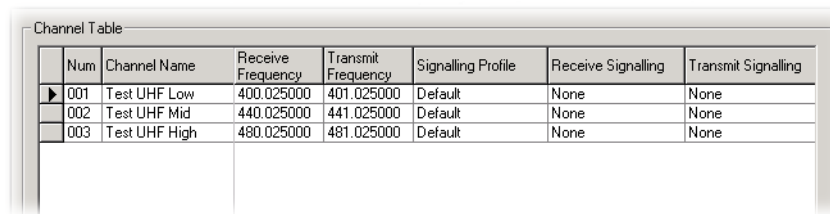

Num	Channel Name	Receive Frequency	Transmit Frequency	Signalling Profile	Receive Signalling	Transmit Signalling
001	Test UHF Low	400.025000	401.025000	Default	None	None
002	Test UHF Mid	440.025000	441.025000	Default	None	None
003	Test UHF High	480.025000	481.025000	Default	None	None

Default Channel

You need to tell the base station which channel to use. The usual way to do this is to use the Service Kit to select one channel in the channel table as the default channel. When the base station starts up for the first time, it selects the default channel unless it is connected to external equipment that selects the channel.

Current Channel

The current channel is the channel that the base station is actually using. Usually, this is the default channel. However, external equipment can use digital input lines to choose another channel. Moreover, Task Manager can instruct the base station to change channel. It can even select another channel to be the default. Monitor > Monitoring > Channel displays the current channel.



Note: If the base station is reset, it starts up on the default channel, unless external equipment defines another channel.

Profiles

Profiles are groups of configuration settings. They simplify the task of configuring channels. The base station has a large number of configuration settings, but most of these will be the same for all channels. Instead of configuring all options many times over for each channel, you configure them once in a profile. You then assign the profile to the appropriate channels (if you are working with the default profile, this is already done for you).

Two profiles group almost all configuration settings: the channel profile (which defines the signal path for example) and the signalling profile (which defines the subaudible signalling and tail timers).

The way you work with profiles varies, depending on whether the base station has an Advanced Profiles and Task Manager license.

Using Default Profiles

The standard base station can only use the default profiles. You define most configuration settings globally in the two default profiles, and then you define the rest individually for each channel in the [channel table](#).

Using Custom Profiles

If the base station has the Advanced Profiles and Task Manager license, additional options are available and you can create a set of custom profiles. To configure an individual channel, you assign custom profiles to it. The only items you configure in the channel table are the transmit and receive frequencies.

Subaudible Signalling

The TB8100 base station can transmit and receive using subaudible signalling. Both [CTCSS](#) tones and [DCS](#) codes are supported. CTCSS attaches a subaudible tone to the carrier signal. DCS attaches a digital code. A receiver programmed with a particular tone or code will not unmute unless that tone or code is presented with the RF signal.

CTCSS tones and DCS codes are referred to collectively as subtones. Subtones make it possible for different groups of users to operate on the same channel without hearing or disturbing each other. The base station and the radios that use it need to be programmed with the same subtone(s). In some parts of the world, the use of subtones is regulated.

Assigning subtones

You assign a receive and a transmit subtone to a channel by editing the channel table. When the base station is operating on that channel, it opens the receiver gate to signals with the receive subtone and transmits using the transmit subtone.

If the base station has a license for the Advanced Profiles and Task Manager feature set, you can use a custom signalling profile to assign up to 16 subtones to a single channel. The receiver recognizes any of the assigned tones and responds according to its configuration for the particular tone. It can transmit the signal (encoding it with the same subtone), transmit the signal (with a different subtone), or carry out a Task Manager action. You can also add an audible reminder tone to the transmissions (for example, for customers who are behind with their payments). The 16 subtones can contain CTCSS tones and DCS codes.

Matching DCS codes

Matching the base station's DCS code to the code programmed into a group of radios can be tricky. This is because the polarity of a DCS code can become inverted. For example, a radio has a DCS code of 017 but the base station may need to be programmed with 050 (017 inverted). Either use simple trial and error to see which code works, or make test calls on the radios while running the base station's subaudible scan diagnostic test, to find out what codes the base station is receiving.

Advanced options

The base station always transmits a DCS end tone for muting the receive audio, but transmitting a CTCSS reverse tone burst is optional and configurable. The base station receiver can also be configured to respond to reverse tone bursts if they are expected.

Power Saving

The TB8100 base station can save power by switching off parts of its circuitry. The standard base station has a limited ability to reduce the current that the base station uses, but the Power Saving Modes license lets you configure three different power saving modes. This gives greatly increased flexibility and makes it possible to get the power savings needed with a minimum sacrifice in quality of service.



Note: Power saving only occurs when the base station is battery-powered. It is not available if the PMU supplies more than one base station.

Power saving modes

A base station with a Power Saving Modes license can operate in Normal, Sleep, and Deep Sleep modes. These modes are enabled and configured in the Service Kit.

	Normal	<input checked="" type="checkbox"/> Sleep	<input checked="" type="checkbox"/> Deep Sleep
Rx Cycling:	No Cycling	50 ms	1 second
Tx Keyup time:	1 ms	medium	slow
Start after:		10 minutes idle	1 hour idle

The base station begins in Normal mode. If the base station is idle (receives no [valid signal](#)) for a defined length of time, it switches to Sleep mode, which saves more power. If the base station is idle for a further defined length of time, it switches to Deep Sleep mode, saving even more power. When it receives a valid signal, it reverts to Normal mode.

Both receiver and transmitter contribute to the power saving.

The receiver is switched off, and then periodically switched back on. If it detects a valid signal, it stays on, otherwise it is switched off again. The power amplifier is always off when the base station is not transmitting. In power saving, other parts of the transmitter circuitry are switched off as well. The longer the Tx keyup time you select, the more circuitry is switched off.

Response times

The more power saved, the longer the response time. Initially, the radio user needs to press PTT and wait before speaking, to give enough time for the receiver to come back on and for the transmitter to key up.

Configuring power saving

You configure power saving when you define the channel profile that the base station will use. For each mode, you specify Rx cycling (how long the receiver stays switched off before it wakes up to check if there is a valid signal and the Tx keyup time. In addition, you specify how long the base station must be idle before it enters Sleep and Deep Sleep modes. The exact amount of power saved varies, depending on the model of base station and the pattern of traffic.

Task Manager

Task Manager is the ‘brains’ of the base station. When something changes, Task Manager carries out actions based on the intelligence contained in its list of tasks. Each task defines what you want the base station to do in response to a particular event.

For example, when the battery voltage low alarm is triggered, Task Manager can tell the transmitter to reduce its power output. If an alarm you want to know about is triggered, Task Manager can tell the base station to start the over-the-air alarm or email you a [status message](#) via the [Alarm Center](#). If a [line-controlled base station's](#) line fails, Task Manager can tell the base station to function as a [talk through repeater](#).

Task Manager is essential for sending alarms to the Alarm Center, for emailing alarms and status messages, and for turning over-the-air and over-the-line alarms on and off. It can also carry out override actions that enable or disable many configured base station functions.

If the base station has an Advanced Profiles and Task Manager license, you can initiate any action simply by sending the base station a CTCSS tone or DCS code. Task Manager can also change the whole operating configuration simply by changing to another channel that uses different profiles.

Task Manager only operates when the base station is in Run mode.

Modifying Task Manager

To change the way Task Manager works, you add and modify tasks using the Service Kit, and then you program the changes into the base station. In effect, you are creating scripts that make the base station perform simple actions. This customizes the way the base station operates without modifying its firmware. Task Manager can perform many functions that previously required expensive external equipment.

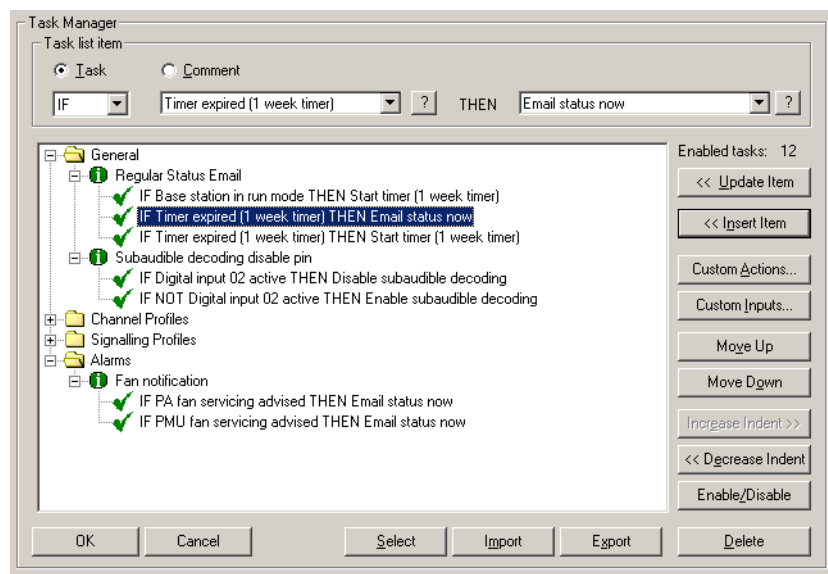

In a standard base station, Task Manager can process up to 20 tasks. In a base station with an Advanced Profiles and Task Manager license, Task Manager can process up to 200 tasks.

Tasks and Comments

Task Manager acts only on the basis of the tasks in its task list. A task is rather like computer code and takes the form:

IF < input> THEN <action>

When the IF part of the task becomes true, the THEN part is executed. There are also IF NOT tasks: when the input of such a task becomes false, the THEN part is executed. You can add comments describing the purpose of a task or group of tasks. Comments have no effect on Task Manager processing.

Inputs

Task Manager inputs are of two main types, 'basic' and 'override.' Tasks are processed differently, depending on the kind of input they have. You need to understand these differences if you are creating complex sets of tasks.

Basic inputs

Basic inputs come from various parts of the base station. They include all alarms. While basic inputs can become true at any time, Task Manager will only process them in the course of the regular 10 ms processing cycle. For example, if an input becomes true in the middle of a processing cycle, Task Manager won't process tasks with that input until the next processing cycle. This is because it only learns of the change after the completion of the first cycle.

Override inputs

Override inputs can only become true through a Task Manager override action. They are internal to Task Manager. Most become true automatically each time the base station enters Run mode.

There are some other inputs that don't quite behave like basic or override inputs. Look under the input for more information.

Actions

Task Manager actions are of two main types, 'override' and 'do now'. These actions have different effects.

Override actions

Override actions enable, disable, or toggle a configured base station function. As most of these functions are enabled by default, the main use of override actions is to let you turn off a function such as talk through repeater, power saving, or even the receiver as a whole. The action changes the state of a flag, which can only be changed by another override action. The status of each flag that is controlled by an override action is displayed in Monitor > Base Station > System Flags.

This flag can also be an override input. When an override action is carried out (for example **Enable power saving**), the equivalent override input (for example **Power saving enabled**) becomes true and any tasks with that input will be processed.



Important: Override actions only enable a function if the base station is already configured for that function using the Service Kit. For example, enabling the talk-through repeater function will only have an effect if the current profile defines a talk-through repeater signal path. If the function is not configured, enabling, disabling, or toggling it will have no effect.

'Do now' actions

'Do now' actions issue a command to the base station to do something immediately, for example to change channel or send the alarm log. This is a one-off action which has no continuing effect on the base station's status. A 'do now' action cannot be re-triggered until the original action is completed. For example, Task Manager cannot carry out the action **Transmit CWID now** when the base station is still transmitting the CWID from a previous **Transmit CWID now** action.

There are some other actions that don't quite behave like override or 'do now' actions. Look under the action for more information.

Custom Inputs and Actions

A task can only have one input and one output. However, you can combine existing inputs or actions to form your own custom inputs or actions.

A custom input combines up to eight different inputs. It becomes true when the combination becomes true, according to the rules of the Boolean logic that you specify for the combination.

Similarly, a custom action can combine up to eight actions. When a task with a custom action is processed, all its constituent actions are carried out.

You can also use counters, timers, and your own flags when defining tasks.

Remote Connections

The TB8100 base station is designed for remote monitoring, diagnostics, configuration, and control. The Service Kit can carry out all these functions remotely. Provided a remote link is in place, you can use the Service Kit to connect and log on to the base station just as if you were directly connected.

The remote link can consist of a telephone line with modems at each end, a pair of radio modems, or a pair of Tait radios that support the CCDI2 protocol.

For each remotely linked base station, you need to create a 'connection,' which is a named configuration that tells the Service Kit how to communicate with the base station.

It is possible to limit remotely connected Service Kit users to read-only access to diagnostics and configuration or even to deny access completely. Local and remote connections have separate access profiles.

With a Remote Monitoring license, the base station can be remotely connected to an Alarm Center. On Task Manager instruction, the base station uses its modem to dial up an Alarm Center and pass on its alarm log or send a status message for emailing.

Alarms

The base station monitors a large number of conditions. When a condition rises above or falls below a defined threshold, the base station generates an alarm and stores it in its alarm log. The alarm log contains the 50 most recent alarms.

Some alarms are inappropriate for particular systems; you can disable any that you do not want.

Most alarms indicate a fault condition, but some are generated by conditions external to the base station, such as mains power failure or loss of RF input.

Alarm Notification Options

The base station is able to notify you in the following ways when an alarm is activated:

- Transmitting pip tones
- Sending pip tones over the line
- Sending the [alarm log](#) to a PC running the Tait [Alarm Center](#) software
- Emailing a status message via the Alarm Center. Status messages contain the alarm log and the current state of monitored parameters
- Activating a digital output line

These methods are configured in the Service Kit but enabled by [Task Manager action](#). As Task Manager has an input for each alarm, its response can vary depending on the alarm. You can create Task Manager tasks that optimize the response for your particular system.

Enabling Alarm Notification

Alarm notification methods need to be set up and configured. Choose carefully which ones to implement, based on the available resources and your policy for remote monitoring. See TN-742, *Remotely Monitoring and Configuring the Tait TB8100*, for details.

To set up an alarm notification method, you may need a physical link (for example, modems and a telephone line). Then you use the Service Kit to configure the method. Finally, you define suitable Task Manager tasks. When something happens, a task is processed that tells the base station to use the method to notify the alarm. Tasks can initiate notification:

- When the base station is started or reset
- When any alarm occurs
- When particularly important alarms are triggered

System Interface

The base station reciter can be fitted with a system interface board. Several different boards make a variety of inputs and outputs available for different applications.

Select Monitor > Module Details > Reciter to see which system interface is fitted. Select Configure > Base Station > System Interface and choose the system interface that is fitted. The System Interface form now displays the current pin assignments and lets you configure some of them for external channel assignment. In addition, Task Manager actions make it possible to configure digital input lines to have any of a wide range of functions.

Software Feature Enabler

The TB8100 base station has many capabilities, but some of them require a license before you can use them. The Service Kit lets you enable the feature sets you require. The following feature sets are available:

Default Radio System

Generally, base stations are already licensed with the Default Radio System feature set. Without it, the base station cannot operate in Run mode, but could be used for training.

Alarm Reporting

The Alarm Reporting feature set enables the base station to remotely dial up using a modem. This means that the base station can report alarms to an Alarm Center or email status messages to a technician (this is done via the Alarm Center).

Advanced Profiles and Task Manager

The Advanced Profiles and Task Manager feature set enables the base station to operate according to custom channel and signalling profiles that you define using the Service Kit. It also lets Task Manager process up to 200 tasks.

Power Saving Modes

The Power Saving Modes feature set makes it possible for the base station to operate in Sleep and Deep Sleep modes. This takes full advantage of the power management unit's power saving capabilities.

Part B Getting Started

Establishing a Service Kit session with a base station is a three-stage process. First you connect a cable (or set up a remote link), and then you establish communications with the control panel. Finally, you log on.

In a Service Kit session, you can monitor the base station and carry out diagnostic tests. You can also view the base station's configuration.

To learn how to program the base station, go straight to the configuration tutorial.

Topics

- [Connecting and Logging On](#)
- [Monitoring Alarms](#)
- [Monitoring the Base Station](#)
- [Viewing Configuration Settings](#)
- [Diagnosing Problems](#)
- [Configuration Tutorial](#)

Connecting and Logging On

The following instructions describe how to connect a Service Kit to a base station via a direct link to the control panel. You can connect remotely using a similar procedure, if a physical connection has been set up. For more detail, see [“Connecting to a Base Station System” on page 38](#) and [“Logging On to a Base Station” on page 39](#).

To connect and log on to a base station

1. If the Service Kit is not already running, select Start > Programs > Tait Programming Applications > TB8100 Service Kit.
2. Connect the supplied cable or a standard mouse extension cable from a serial port on your PC to the serial port on the control panel.
3. On the toolbar, click the **Connect** icon. The Connecting dialog box appears.

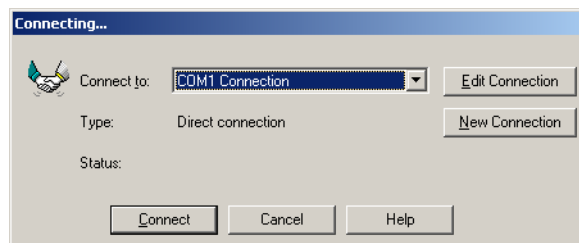

4. In the **Connect to** box, select a connection for the serial port you used. The Type field now shows 'Direct connection.'
5. Click **OK**. The **Log On** dialog box appears.

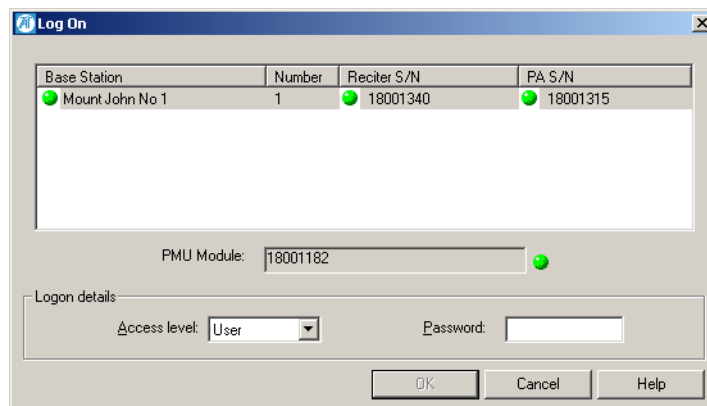

6. Log on to one of the base stations in the [base station system \(BSS\)](#), as follows.
 - a. In the Base Station column, select a base station.
 - b. Select an [access level](#).
 - c. Enter the password for that level of access to the base station. (For more information, see [“Logon Details” on page 40](#).)
 - d. Click **OK** to log on and close the dialog box. The status bar shows the name of the connection and the base station you are logged on to.

You can now monitor the base station, conduct diagnostic tests, and read and modify the base station’s configuration.

Monitoring Alarms

When you are logged on to a base station, the Service Kit regularly polls the base station for alarms. If an alarm is detected, a flashing Alarms icon appears in the status bar. If the Alarms icon disappears, the Service Kit has detected that the alarm was cleared.

To monitor alarms

1. Check the status bar. If it has a flashing Alarms icon, click the Alarms button on the toolbar. This opens the Current Status form.

The 'Current Status' form is divided into several sections, each with a list of alarms and their status (indicated by a green LED icon for active and a white LED icon for cleared):

- Reciter:**
 - Power up failure (Green LED)
 - Channel invalid (Green LED)
- Synthesiser out of lock:**
 - Exciter (Green LED)
 - Digital (Green LED)
 - Receiver (Green LED)
- System:**
 - Balanced input low (White LED)
 - Unbalanced input low (White LED)
- External reference:**
 - Absent (White LED)
 - Invalid (Green LED)
- RSSI:**
 - High (Green LED)
 - Low (White LED)
- Air intake temperature:**
 - High (White LED)
 - Low (White LED)
- Power Amplifier:**
 - No PA detected (Green LED)
 - Fan failed (Green LED)
 - Shutdown (Green LED)
 - VSWR high (Green LED)
 - Current:
 - Driver high (Green LED)
 - Final 1 (Green LED)
 - Final 2 (White LED)
 - Imbalance (Green LED)
 - Supply voltage:
 - High (Green LED)
 - Low (Green LED)
- Power Management Unit:**
 - No PMU detected (Green LED)
 - Fan failure (Green LED)
 - Shutdown imminent (Green LED)
 - Battery:
 - Voltage high (Green LED)
 - Voltage low (Green LED)
 - Protection mode (Green LED)
 - Output:
 - Voltage high (Green LED)
 - Voltage low (Green LED)
 - Current high (Green LED)
 - Mains supply failed (Green LED)
 - Power up fault (Green LED)
 - Temperature high (Green LED)
- Temperature high:**
 - Driver (Green LED)
 - Final 1 (Green LED)
 - Final 2 (White LED)
- Other Alarms:**
 - Power foldback (Green LED)
 - Forward power low (Green LED)
 - Reverse power high (Green LED)
 - Calibration invalid (Green LED)
 - H/W configuration invalid (Green LED)

2. Look to see which LED is flashing red. A flashing LED means that the alarm is on. One problem can set off more than one alarm.



Tip: To view a list of recent alarms, select Monitor > Alarms > Reported Alarms.



Note: Most monitoring forms have an Alarm Status LED, which indicates whether the module has any active alarms.

Monitoring the Base Station

Once you are logged on to a base station, you can monitor various aspects of it.

To view a monitoring form

1. On the toolbar, click **Monitor**. The navigation pane displays a menu of options.
2. In the navigation pane, click a subheading (for example 'Reciter').

The main part of the Service Kit window displays information relevant to the subheading.

Options

- To view the current status of all base station alarms, select Alarms > Current Status.
- To view information about the modules belonging to the base station, select an item under Module Details.
- To view information about the way the base station is currently operating, select an item under Monitoring.

Viewing Configuration Settings

From the Service Kit, you can view a base station's configuration settings. This information must be read after you have logged in to the base station.

To view configuration settings

1. On the toolbar, click **Read**.

The Reading dialog box displays progress.

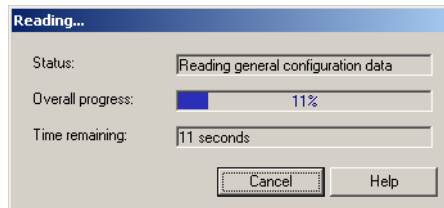

2. On the toolbar, click **Configure**. The navigation pane displays a menu of options.
3. In the navigation pane, click a subheading (for example 'General'); the main part of the Service Kit window changes to display the corresponding form.

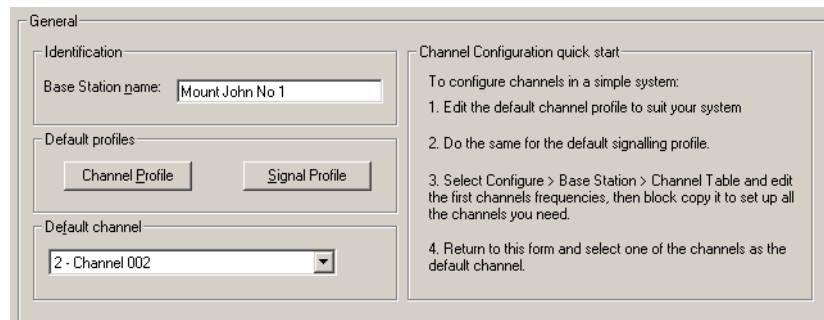

In this way, you can view any aspect of the base station's current configuration.

Diagnosing Problems

From the Service Kit, you can carry out a variety of tests on aspects of the base station you are logged on to. These can help you diagnose any problems you may be experiencing. The base station must be in Standby mode, which takes it out of active service.

To carry out a diagnostic test

1. On the toolbar, click **Diagnose**. The navigation pane displays a menu of options.
2. Click the **Mode** icon and select Standby mode. This takes the base station out of service.
3. In the navigation pane, click a subheading (for example 'Self Tests'); the main part of the Service Kit window changes to reflect your selection.
4. Click **Start Test**. View the results of the test on-screen.
5. If necessary, click **Stop Test**.
6. Return the base station to Run mode.

Configuration Tutorial

The following tutorial shows you how to make some basic changes to the standard configuration that turn the TB8100 into a basic repeater. You modify the signal path, change from carrier gating to noise gating, optionally configure subaudible signalling, and set the receive and transmit frequencies. The aim is to get you started and to introduce you to some of the many configuration settings that are covered in the online Help and the manual.

Step 1: Install the Service Kit and Calibration Kit on your PC

1. Insert the CD-ROM in your CD-ROM drive.
2. If the CD does not autoplay, select Run from the Start menu and use the Browse button to select `Setup.exe` from the `d:` drive, where `d` is the CD-ROM drive,
3. Follow the on-screen instructions.

You are given the opportunity to install the Alarm Center as well. If your system is designed for an Alarm Center, do this separately on a dedicated PC.



Note: If the base station does not have the required switching range, use the Calibration Kit to adjust it. This should be done before you configure the base station. See the Operation Manual and the

Calibration Kit online Help for instructions.

Step 2: Connect and Log On

1. Using the cable supplied, connect a serial port on your PC to the serial port on the subrack front panel.
2. Select Start > Programs > Tait Programming Applications > TB8100 Service Kit.
3. On the toolbar, click **Connect**.

The Connecting dialog box appears.

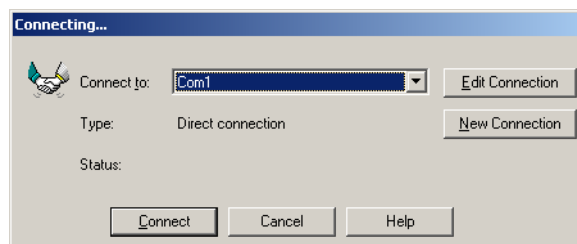

4. In the **Connect to** box, select Com1 or Com2, depending on the serial port you connected the cable to.

- Click **OK**. The **Log On** dialog box appears.

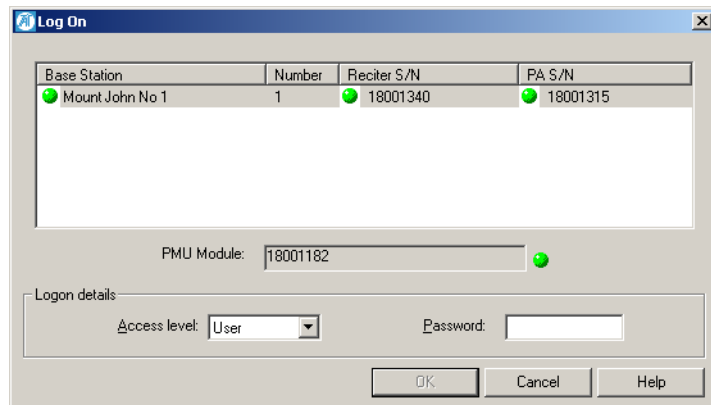

- In the Base Station column, select a base station.
- Select the User access level and enter the equivalent password (the default is user).
- Click **OK** to log on.



Tip: You can get the base station receiving and transmitting on the frequencies you want without changing its configuration. Use the set receiver frequency and transmission diagnostic tests.

Step 3: Read the Base Station's Configuration



- Click **Read**. The Reading dialog box displays progress.

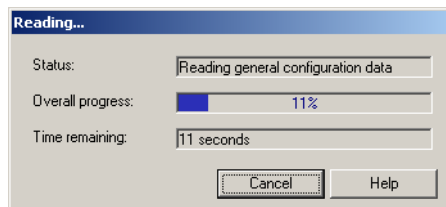

- Click **Configure**. The navigation pane displays a menu of options for configuring the base station.

Step 4: Configure the Base Station as a Talk-Through Repeater

- In the navigation pane, under Base Station, click General.

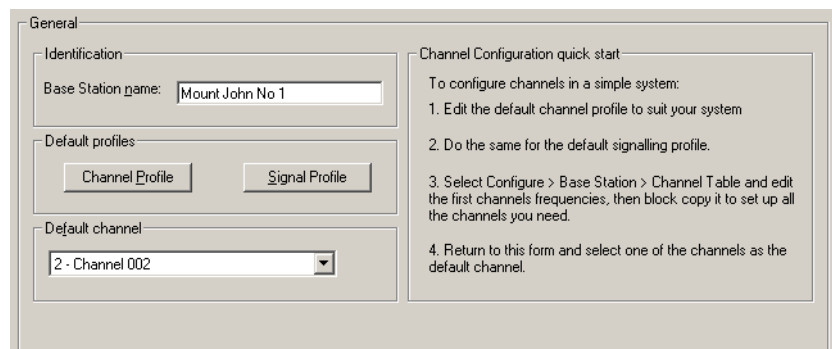

2. Click **Channel Profile**. The Edit Channel Profile dialog box appears.

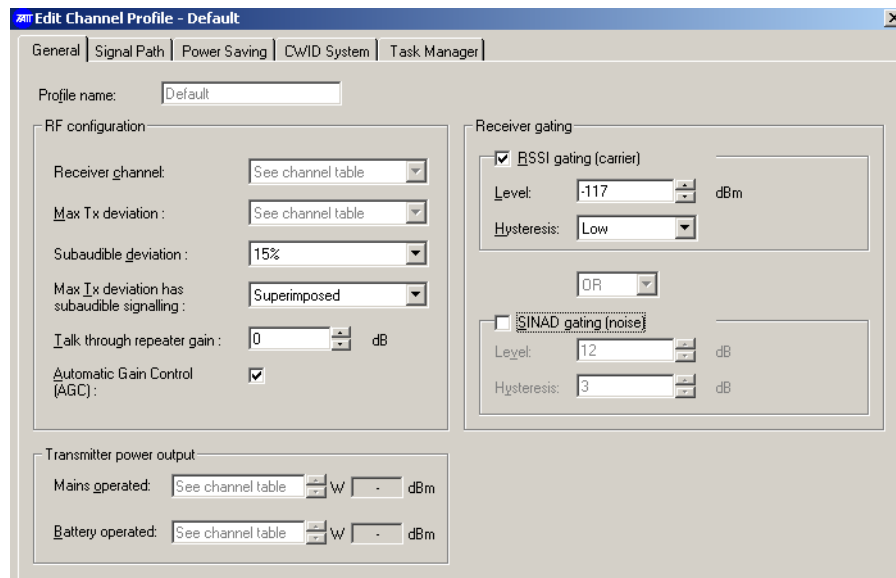

3. In the Receiver gating area, clear the **RSSI gating** check box and select the **SINAD gating** check box. Specify a level of 12 dB and a hysteresis of 2 dB.
4. Click the **Signal Path** tab.

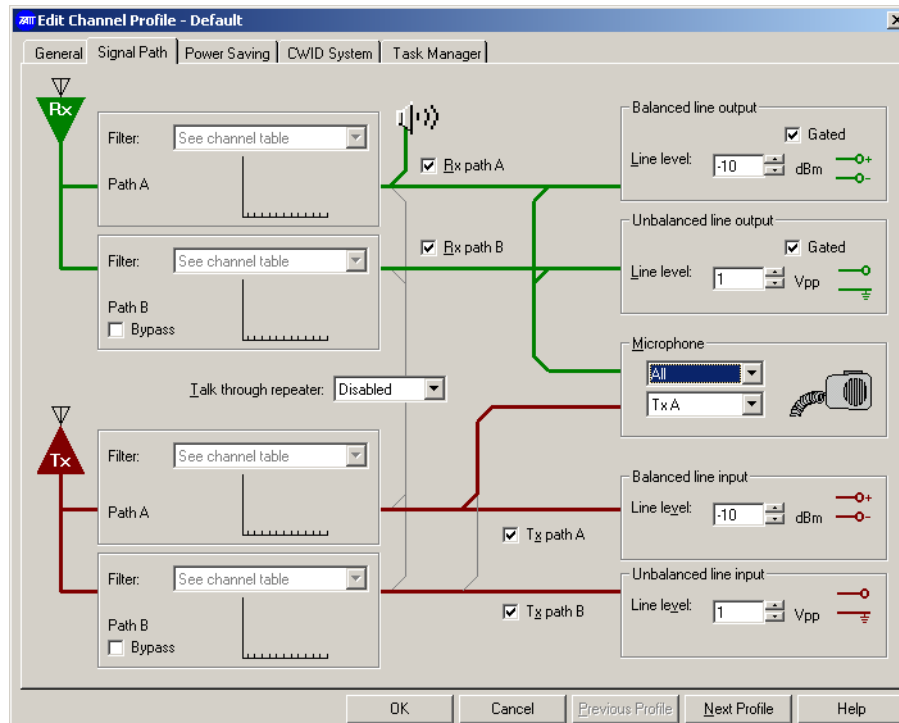

5. In the **Talk through repeater** list, click A-A. A thick line now connects the receive Path A to the transmit Path A.
6. Make any other changes to the default channel profile, and click **OK**.

Step 5: Configure a Channel

1. In the navigation pane, under Base Station, click Channel Table.

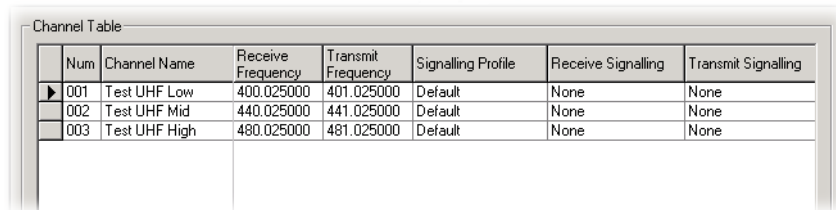

Num	Channel Name	Receive Frequency	Transmit Frequency	Signalling Profile	Receive Signalling	Transmit Signalling
001	Test UHF Low	400.025000	401.025000	Default	None	None
002	Test UHF Mid	440.025000	441.025000	Default	None	None
003	Test UHF High	480.025000	481.025000	Default	None	None

2. Decide which channel the base station will operate on.
3. In that channel's row, enter receive and transmit frequencies.
4. Click in the **Receive Signalling** cell and select a CTCSS tone or DCS code. Do the same for **Transmit Signalling**.
5. Use the scroll bar to display the hidden columns in the table.
6. In the **Filter** column, select Pre-De-Emph Speech Band.
7. In the **Channel Spacing** column, select an option.
8. Click **OK**.

Step 6: Set the Default Channel.

1. Return to the General form.
2. In the **Default channel** area, select the channel you configured.
3. Click **OK**.

Step 7: Program the Changes into the Base Station

1. Click **Save** to save your changes to a file, giving it a suitable name.
2. Click **Mode** and put the base station in Standby mode.
3. Click **Program**. The Programming dialog box appears and indicates progress.

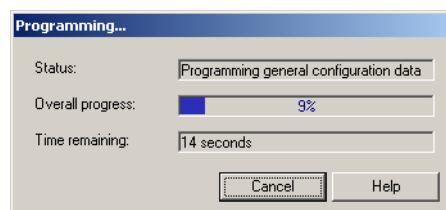

When all the configuration information has been downloaded, it is programmed into the base station. When the Service Kit receives confirmation of this, it closes the dialog box.

4. Return the base station to Run mode. It is now operational.

Part C Basic Tasks

Before you can get down to the real work on a base station, you need to know how to carry out basic tasks such as setting up a connection, changing the base station's mode, or reading configuration information.

The Basic Tasks section explains in detail how to do these and other preliminary tasks.

Topics

- [Using the Service Kit](#)
- [Setting Service Kit Options](#)
- [Setting Up and Configuring Connections](#)

- [Connecting to a Base Station System](#)
- [Logging On to a Base Station](#)
- [Changing Base Station Mode](#)
- [Working With Base Station Configurations](#)
- [Logging Off and Disconnecting](#)

- [Changing Base Station Passwords](#)
- [Access Profiles](#)
- [Working with Different Versions](#)
- [Upgrading Base Station Firmware](#)
- [Working with the Software Feature Enabler](#)

Using the Service Kit

When you start the Service Kit, a splash screen appears, followed by the application window.

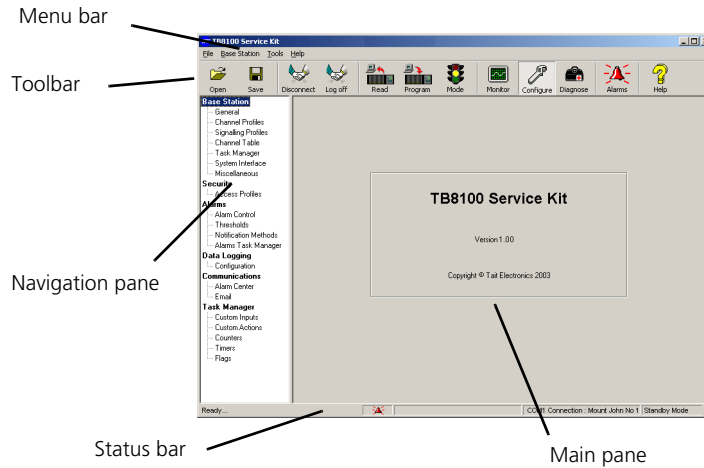

By default, the Monitor icon on the toolbar is selected and the navigation pane gives you options for monitoring. When you click an item in the navigation pane, the main pane displays the corresponding form.

Toolbar

The toolbar gives you quick access to commonly used menu commands. For example, instead of selecting Base Station > Configure, click the Configure icon on the toolbar.

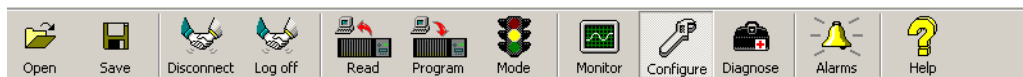

- | | |
|---------|---|
| Open | Lets you open a configuration file that is stored on the Service Kit computer. |
| Save | Saves the open configuration. When saving a configuration file for the first time, you are asked to give it a name. |
| Connect | Lets you select a BSS to connect to. When you are connected, the button changes to Disconnect. See also “Connecting to a Base Station System” on page 38. |
| Log on | Lets you log on to a base station, once you are connected to the BSS. When you are logged on, the button changes to Log off. See also “Logging On to a Base Station” on page 39 |
| Read | Reads in the configuration information of the base station you are logged on to. See also “Working With Base Station Configurations” on page 42. |

Program	Sends the whole set of configuration information in the Service Kit to the base station. The base station must be in Standby mode. Once programmed, the base station operates using the new configuration. See also “Working With Base Station Configurations” on page 42.
Mode	Lets you change the base station’s operation mode. The traffic light indicates the current mode. Green means Run mode, Orange means Standby mode, and Red means Download mode. See also “Operation Modes” on page 4.
Monitor	Lets you monitor the base station. See also “Monitoring the Base Station” on page 21.
Configure	Lets you view and edit a configuration. If a configuration is not already selected, you are given the option of creating a new configuration, opening an existing one, or reading the base station’s current configuration. See also “Viewing Configuration Settings” on page 22.
Diagnose	Lets you carry out diagnostic tests on the base station. See also “Diagnosing Problems” on page 23.
Alarms	Turns red when any base station alarm is triggered. Click Alarms to display the current status of all base station alarms. See also “Monitoring Alarms” on page 133.
Help	Displays a Help topic for the form or dialog box you are currently in.

Status Bar

The status bar provides you with useful information that supplements the display in the main pane.

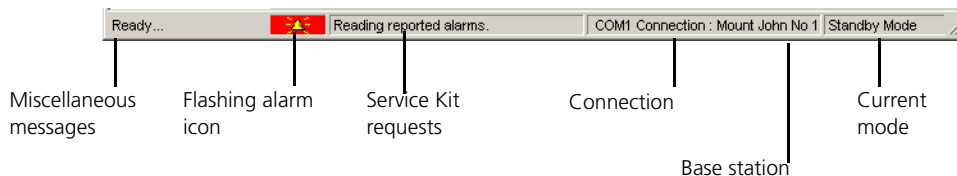

Miscellaneous messages appear on the left. Four panels in the status bar contain a flashing alarm icon (when an alarm is triggered), any Service Kit requests, the name of the connection followed by the name of the base station that the Service Kit is logged on to, and the mode that the base station is currently in. ‘Ready’ means that the Service Kit has completed the last user request and is ready to respond to another request.

Setting Service Kit Options

The Options dialog box (Tools > Options) lets you indicate some preferences.

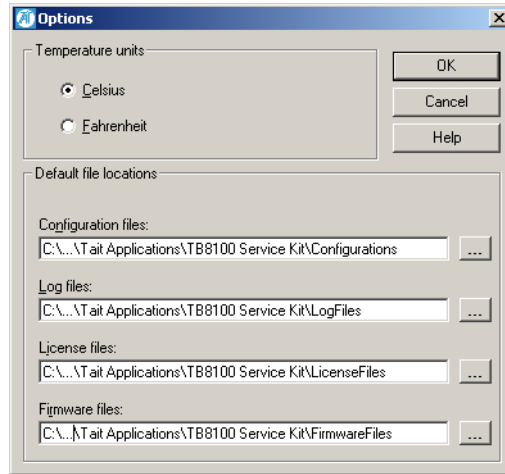

Temperature units

The Temperature units area specifies whether the Service Kit displays temperatures in Celsius or in Fahrenheit.

Default file locations

The Default file locations area specifies folders for configuration files, log files, license files, and firmware files. To modify a default location, click the button to the right of the box and select a folder.

Configuration files

When you save a configuration file for the first time, the folder specified in the Configuration files box is shown in the dialog box. You can select another folder if you want. (You already chose a folder for configuration files during installation.)

Log files

Specifies where the Service Kit stores the alarm log and error log.

License files

Specifies where the Service Kit will look for license files when you ask it to enable additional feature sets in a base station. If you receive a license file, copy it to this folder.

Firmware files

Specifies where the Service Kit will look for firmware files when you ask it to download new firmware into a base station. If you receive new firmware for a base station upgrade, copy it to this folder.

Setting Up and Configuring Connections

The **Connections** dialog box (Tools > Configure Connections) displays a list of user-defined [connections](#). It lets you add new connections or edit existing ones. When you connect to a BSS, you select one of the connections that you have created or edited.

There are different connection types, reflecting the different ways that the Service Kit can be physically connected to a BSS. (For information on remote connections to a BSS, see *TN-742 Remotely Monitoring and Configuring the Tait TB8100*.) You only need one connection for connecting directly to any BSS, but you need a different connection for each remotely connected BSS.

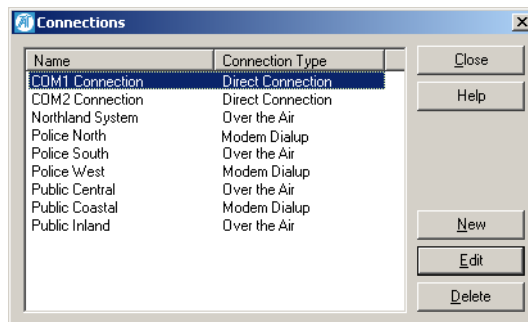

If your PC has no serial port, obtain a USB to Serial (DB9) converter. When the driver for this is installed, the operating system makes a virtual serial port available.

Adding a Connection

The New Connection dialog box lets you define new connections and add them to the list of available connections. There should already be direct connections for COM1 and COM2. You need to set up one connection for each BSS with a remote link.

Adding a Direct Connection

1. Select Tools > Configure Connections. The Connections dialog box appears.
2. Click **New**. The New Connection dialog box appears.

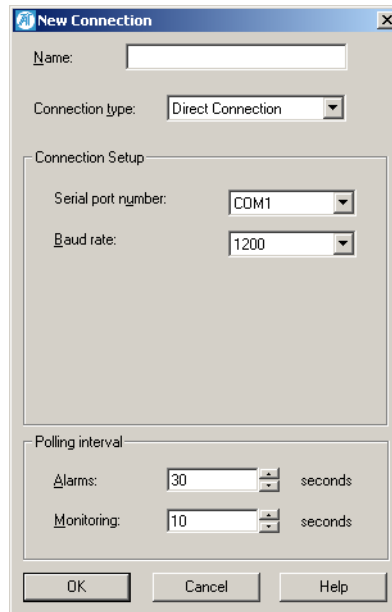

3. In the **Name** box, enter a suitable name, for example 'All'.
4. In the **Connection type** box, select Direct Connection.
5. In the **Serial Port Number** box, select the port on your PC that will be used by the cable from the BSS.
6. In the **Baud rate** box, select a suitable communications speed: for a direct connection, this can be 57,600 or even 115,200 Baud.



Note: You may experience slow or intermittent communications at baud rates of 56k and above. This is not a Service Kit or base station problem; it has been found that serial ports on some older PCs do not operate correctly. Moving the mouse makes the problem worse (use of one serial port affects the other). If you have this problem, select a slower Baud rate.

7. Set suitable polling intervals. These specify the interval from one poll of the base station to another. A direct connection can have very short intervals, for example 1 second for monitoring and 5 seconds for alarms.
8. Click **OK**. The new connection now appears in the Connections dialog box.

Adding a Modem Dialup Connection

For each BSS that is fitted with a dial-up modem, you need to define a connection.

1. Select Tools > Configure Connections. The Connections dialog box appears.
2. Click **New**. The New Connection dialog box appears.
3. In the **Name** box, enter a name that uniquely identifies the BSS.
4. In the **Connection type** box, select Modem Dialup.

The New Connection dialog box now looks like this:

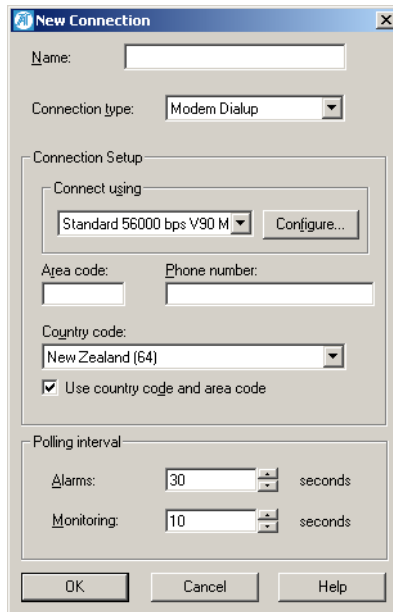

5. If your PC has more than one modem, select the one you want to use in the **Connect using** box. Normally, you do not need to click **Configure** and configure the PC's port to the modem. The default settings can be left as they are.
6. In the **Phone number** box, enter the telephone number of the line to the BSS's dial-up modem. You can enter up to 40 digits: enough for a local pin and an international number.
7. If the Service Kit needs to use the country code and the area code to access the BSS, provide this information as follows.
 - a. In the **Area code** box, enter the BSS's area code.
 - b. In the **Country code** box, select the BSS's country code.
 - c. Select the **Use country code and area code** check box.
8. Set polling intervals that are appropriate to the speed of your connection. The **Alarms** and **Monitoring** boxes specify the interval from one Service Kit poll of the base station to another.
9. Click **OK**. The new connection now appears in the Connections dialog box.

Adding an Over-the-Air Connection

For each BSS that is fitted with a radio modem, you need to define a connection.

1. Select Tools > Configure Connections. The **Connections** dialog box appears.
2. Click **New**. The New Connection dialog box appears.
3. In the **Name** box, enter a suitable name. The name should specify the BSS and the connection type
4. In the **Connection type** box, select Over the Air.
The New Connection dialog box now looks like this:

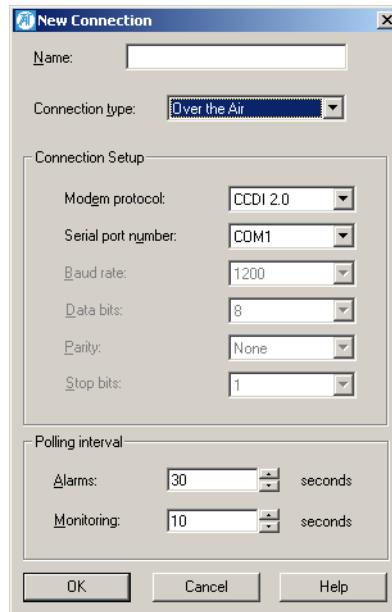

5. In the **Modem protocol** box, select CCDI 2.0 if the radio modem is a Tait radio that supports **CCDI2**. Otherwise, select RF modem. The equipment connected to the BSS must have the same setting.
6. In the **Serial port number** box, select the port on your PC that the radio modem is connected to.
7. If the radio modem doesn't use CCDI 2.0, define the other communications settings. (These settings are fixed for CCDI 2.0.)
8. Set appropriate polling intervals. The **Alarms** and **Monitoring** boxes limit how often the Service accesses the base station to obtain alarm and monitoring information. These intervals need to be long if the equipment is sharing the channel.
9. Click **OK**. The new connection now appears in the Connections dialog box.

Editing a Connection

You may need to modify the settings of an existing connection, for example, if a telephone number changes or if the link is too slow for the polling intervals you selected.

To edit a connection

1. Select Tools > Configure Connections. The **Connections** dialog box appears.
2. Click a connection to select it.
3. Click **Edit**. The Edit Connection dialog box appears.
4. Modify the settings as desired. For information about individual settings, see [“Adding a Connection” on page 34](#).
5. Click **OK**.

Connecting to a Base Station System

Before you can work with a base station, you must connect to its [base station system \(BSS\)](#).

1. Connect the Service Kit physically to the base station subrack. (For a remote connection, this should already be in place: see *TN-742 Remotely Monitoring and Configuring the Tait TB8100*.) For a direct connection, follow these steps:
 - a. Connect one end of the supplied cable to the control panel serial port. This cable is an ordinary (straight through) RS 232 cable and is available separately (order code TBA0P10).
 - b. Connect the other end to a serial port on your computer. The serial port to use is the one specified when the direct connection was set up and configured.
2. Click **Connect**. The Connecting dialog box appears.

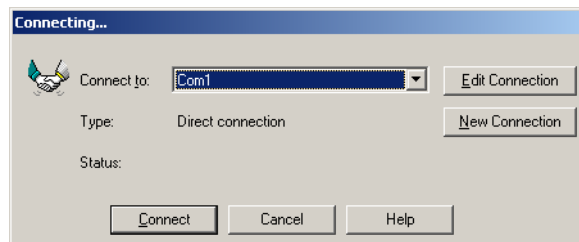

3. In the **Connect to** box, select a named connection from the drop-down list. If no suitable connection exists, click **Edit Connection** or **New Connection** to edit an existing connection or create a new one. For more information, see [“Setting Up and Configuring Connections”](#) on page 34.
4. Click **Connect**. You can now log on to a particular base station.

Logging On to a Base Station

Once the Service Kit is connected to a BSS, you can log on to one of its base stations. Logging on establishes a communication session with the base station. Data can go back and forth, for example, to display monitoring information or to carry out a diagnostic test. However, a further step is necessary before you can work with configuration information: you must read the base station or open a [configuration file](#), even to view the configuration forms.

The Log On dialog box contains a table that lists the base stations in the BSS and a Logon details frame that lets you log on.

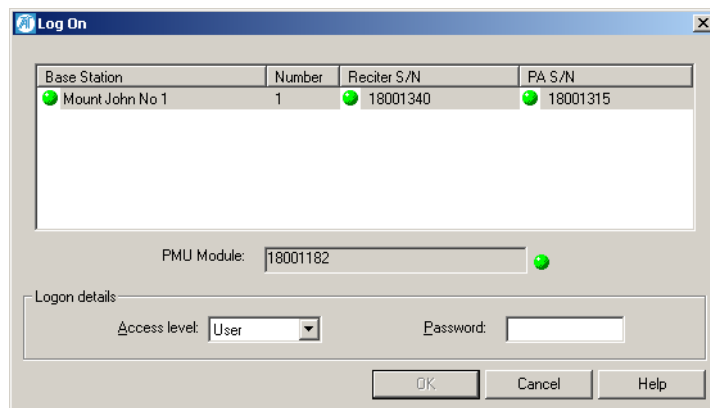

Base Station Table

Each row in the base station table displays information about a base station. LEDs indicate whether an alarm is active so that you can go first to the base station with the alarm and monitor or diagnose the module with the alarm.

The PMU serial number is displayed in its own box, because it serves the whole BSS.

Each module has an LED. If an LED is red, the module has an active alarm. If it is green, there are no active alarms.

Base Station	Displays the name of the base station. The LED to the left indicates whether the whole base station has any alarms. The base station name is defined in Configure > Base Station > General: Identification area.
Number	The number of the base station's reciter. This defines the reciter's address on the control bus and is set by the rotary switch on the reciter front. Reciter number 1 is the control bus master.
Reciter S/N	The serial number of the reciter. The LED to the left indicates whether the reciter has any alarms.
PA S/N	The serial number of the power amplifier. The LED to the left indicates whether the PA has any alarms.

Logon Details

The Logon details area lets you enter information for the log on.

Access level

Defines the access level for the log on. An access level determines your access to the base station and your ability to carry out different functions. If your access level is 'User', what you can do depends also on the base station's access profile. The access profile is configured by the Administrator.

Access Level	Description
User	Lets you carry out the Service Kit functions that the administrator has selected for the base station in Base Station > Access Profiles. The administrator can specify one set of functions for a direct connection and another for the different kinds of remote connection.
Administrator	Lets you carry out all Service Kit functions on the base station, including changing passwords for access to it.
Read only	Lets you use the Service Kit to monitor the base station but not to change it or carry out any actions. You can read and view the base station's configuration but not change it. You cannot carry out diagnostic tests.



Note: Authorized Tait service centers have a higher level of access when directly connected and do not need to select a level or enter a password.

Password

Enter the password into this box. This is the password for the base station and for the access level you selected. Each base station has its own set of passwords. Passwords can be changed by users with the Administrator access level (see [“Changing Base Station Passwords”](#) on page 46).

Access Level	Default Password
User	user
Administrator	admin
Read only	readonly

Changing Base Station Mode

Some Service Kit operations can only be carried out when the base station is not in its normal operating mode.

To change the base station's operation mode

1. Click **Mode**. (Or, select Base Station > Change Mode.) If you have rights to change mode, the Change Operating Mode dialog box appears.

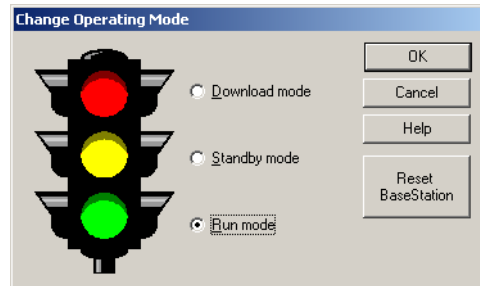

2. Select the mode you want.
 - Modes that you don't have access rights to are disabled.
 - To leave Download mode, reset the base station. The Service Kit displays the Connecting dialog box. Wait about 10 seconds for the base station to start up, then re-connect and log on. The base station is now in Standby mode.
3. Click **OK**.

Resetting the Base Station

You can reset the base station using the Service Kit.

1. Click **Mode**.
2. Click **Reset Base Station**.
3. Wait for the base station to restart, and then connect and log on again.

Working With Base Station Configurations

Base stations are programmed with many configuration settings. Using the Service Kit, you can view these settings, change them, and then program them into the base station. You can also create a new configuration from a template and save a configuration to a file.

- Configuration works differently from other Service Kit functions. Once you are logged on, you can monitor the base station but you can't yet view its configuration. First you must click the Read icon, which instructs the base station to supply its configuration information.
- Programming the base station with a new configuration can only be done when the base station is in Standby mode.
- You can obtain configuration information from a base station, from a [configuration file](#), or from a configuration template.

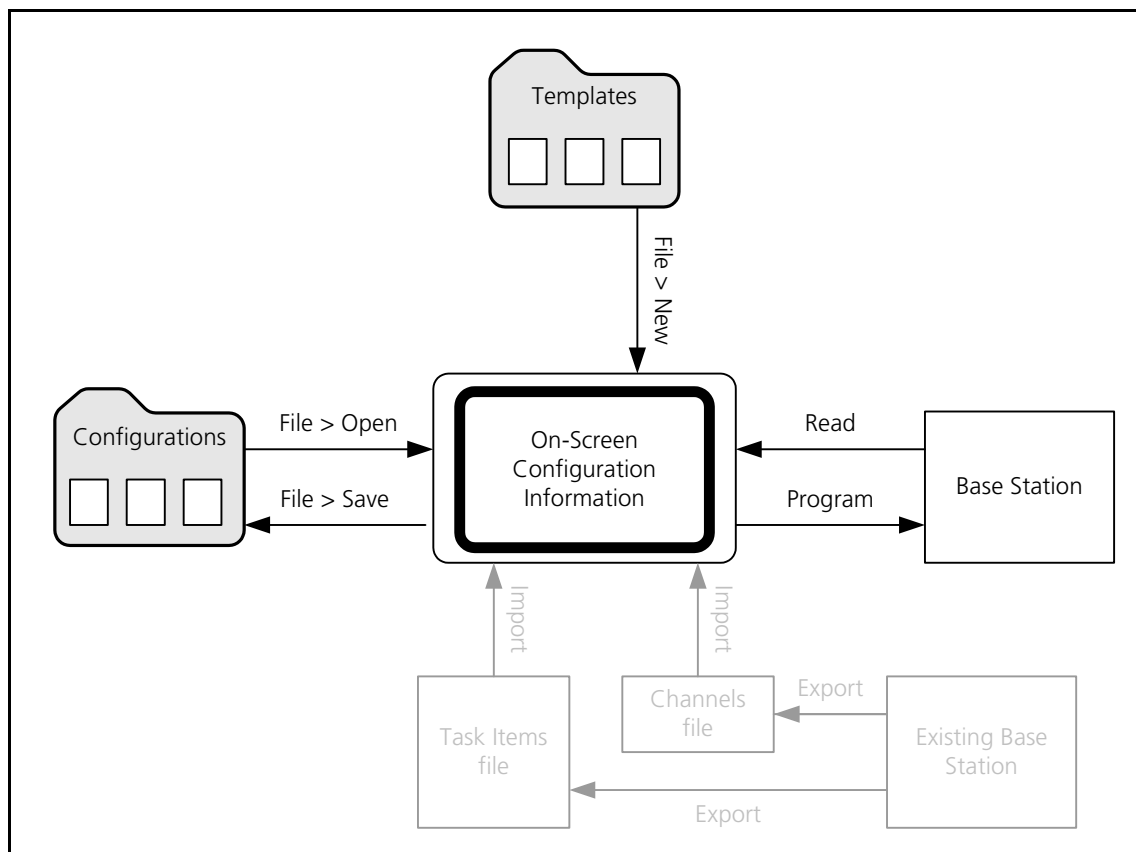

Figure 1: Obtaining Configuration Information

Ways of working with configurations

There are several different methods that you can use to create and maintain base station configurations.

- Read the base station's configuration, modify it, and program the changed configuration back into the base station.
- Create a template from a base station's configuration and use it to create configurations for other base stations.
- Export one base station's channels or task list and import it into other base stations.

Creating a New Configuration

You can create a new base station configuration from scratch, modify it, and save it as a new configuration. This means that you can define a configuration without being connected to a base station. This is a good way to learn how to use the configuration part of the Service Kit program. It also means that you can do all the work of configuring before a base station is delivered. When it arrives, you just open the configuration file and program it into the base station. (This method completely overwrites the base station's current settings.)

To create a new configuration

1. Select File > New. The **Select Template File** dialog box appears.
2. Select an appropriate template (*.t8t file) from the templates in the Template folder. This template will provide a set of default settings. Templates can be provided by Tait or created for your system or organization.
3. Click **Open**.

The title bar displays 'Untitled.t8c', indicating that you have not given the configuration a name and saved it.

You can now click **Configure** to view the current configuration settings, make any configuration changes, and save the configuration settings to a file. You can also program a base station with these settings.

Reading a Configuration

Before you can view a base station's configuration settings, you must read them. If they were saved to a file, they also exist in the Service Kit's Configurations folder.



Note: Reading configuration settings overwrites any settings that the Service Kit has in memory. If you have opened a [configuration file](#), save and close it first.

1. Connect to the BSS and log on to the base station.
2. Click **Read**.

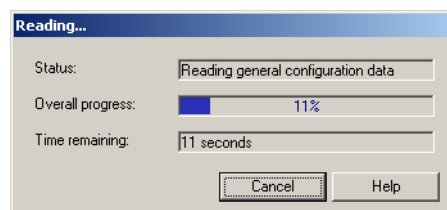

The Service Kit reads the base station's configuration information. If this information was saved to a file, the Service Kit loads the information from that file. This is much quicker, especially for remote connections. It checks to make sure that the information on file is the same as the information in the base station. If some parts of the configuration in the base station have been updated after the file was saved, these parts are read from the base station.



Important: When you read a configuration and the base station cannot detect its PA or PMU, it is unable to provide the configuration settings that are stored in the module. The Service Kit fills in the gaps by providing default settings. If this occurs, you might subsequently overwrite the module's settings with defaults that are unsuitable for your system. Before re-programming the base station, check and edit these default settings. They include alarm thresholds and the auxiliary power output configuration.

The **Reading** dialog box displays progress and gives you the option of canceling the process. The title bar displays the name of the configuration file. Any changes you make and save will be saved to this file. (If the title bar displays 'Untitled.t8c,' you need to specify a file name when you save your changes.)

You can now click **Configure** to view the current configuration settings, make any configuration changes, and save the configuration settings to a file. You can also put the base station into Standby mode and program it with the new settings.

Saving a Configuration

It is a good idea to regularly save your current configuration settings as you work on them. You should also save them when you program them into a base station. In this way, you have a backup. The Service Kit can automatically use this to quickly load the settings if you need to read them again. It is also available in case the base station fails or its memory becomes corrupt.

To save configuration settings

1. After making any changes to configuration settings, click **OK** to confirm them.
2. Select File > Save or click **Save**.

If the configuration settings are already named, they are saved. If not, the Save Configuration File dialog box appears and you must continue as follows:

3. Enter a name for the configuration file into the **File name** box.
4. If you want to save the configuration file somewhere other than in the Configurations folder, alter the default path.
5. Click **Save**. The name you provided appears on the title bar.

Programming a Base Station

To change a base station's configuration settings, you must make the changes using the Service Kit, and program them into the base station. Programming only affects the settings that you can view after clicking **Configure**.

To program a base station

1. Log on to the base station (if you aren't already).
2. Click **Mode** and put the base station into Standby mode.
3. Check that the current configuration settings displayed in the Service Kit are what you want. Click **OK** to confirm this.
4. Select File > Save to create a copy of the configuration settings as a file in the Configurations folder.

5. Click **Program**.

The Programming dialog box appears and indicates the download progress. When the base station has successfully received all the configuration settings and programmed them in, the Programming dialog box closes.

If the download is not completely successful, programming is aborted and a message appears. Later, you can open the file you saved and try again.



Important: When you program a base station, any changes to the PMU configuration will affect the operation of the PMU, which supplies the other base station in the BSS. That base station's operation may be interrupted or otherwise affected.

6. Return the base station to Run mode.

Creating a Configuration Template

The base station comes with templates that define configuration settings for different applications. When you create a new configuration, the template you select provides the configuration with sensible default settings. This enables you to concentrate on the main things that need to be changed.

You may want to add your own template. You can then quickly create a configurations with the settings you want. These could be settings common to all base stations in a system or settings that a system integrator generally uses.

To create a configuration template

1. Edit the settings in a configuration file until they are as you want them. Click **OK**.
2. Save the file.
3. Select File > Save as Template. The Save Configuration Template dialog box appears.
4. Enter a name for the template.
5. Click **Save**. The Service Kit saves the configuration settings to a template file. This file has the name you entered and the template extension (.t8t).

Changing Base Station Passwords

Each base station stores its own password for each of the three access levels. If you log on to the base station as Administrator, you can change any of these passwords. While the base station is password-protected, the Service Kit is not.

To change a password

1. Select Base Station > Change Passwords, and then select the appropriate sub-option for the password that you want to change. The Change User Password dialog box appears.



The image shows a dialog box titled "Change User Password". It contains three text input fields: "Administrator password: (required for security)", "New password:", and "Confirm new password:". Below the fields are two buttons: "OK" and "Cancel".

2. Enter the Administrator password.
3. Enter the new password.
4. Re-enter the password in the next box.
5. Click **OK** to change the password and close the dialog box.



Important: Take care not to lose the Administrator password.

Access Profiles

The Access Profile dialog box (Base Station > Access Profiles) lets you view or edit information about the access that Service Kit users have to the current base station. This access varies, depending on the access level.

- The 'Administrator' access level gives unrestricted access.
- The 'Read Only' access level lets you view everything but change nothing.
- The 'User' access level has a configurable access profile. This means that your access to the base station varies, depending on the type of connection and the Service Kit function.
- Tait-authorized service centers always have unrestricted access when locally connected.

Viewing an Access Profile

You may need to check and see what functions you are permitted to carry out on a particular base station.

To view your access profile

1. Log on to the base station.
2. Select Base Station > Access Profiles. The Service Kit reads access profile information from the base station and displays it in the Access Profiles dialog box.

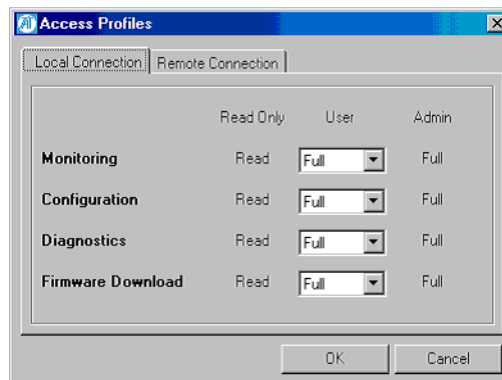

The dialog box has two tabs, one for local (direct) connections and the other for remote (dial-up or over-the-air) connections. There is a row for each major area of the Service Kit program and a column for each access level. Access can be any of the following:

Option	Description
Deny	The Service Kit opens the form you request, but it is disabled and displays no data.
Read	The Service Kit opens the form and displays the data, but you cannot edit it. You can display the information in diagnostic screens, but not initiate any diagnostic tests.
Full	The Service Kit lets you do anything it is capable of.

Modifying Access Profiles

Those with Administrator access can configure the access profiles of those with a 'User' access level. One access profile is for local (direct) connections, the other for remote (dial-up or over-the-air) connections. You could for example allow these users to carry out diagnostic tests but only to view the base station's configuration.

To modify an access profile

1. Log on to the base station as 'Administrator.'
2. Select Base Station > Access Profiles. The Service Kit reads access profile information from the base station and displays it in the Access Profiles dialog box.
3. Make changes to any settings in either tab.
4. Click **OK** to program your changes into the base station and close the dialog box.

Logging Off and Disconnecting

When you have finished working with a base station, click **Log Off** to log off or **Disconnect** to disconnect from the BSS. Logging off lets you immediately log on to the other base station in the BSS.

If the base station is in Standby or Download mode, you are reminded of this and asked to confirm that you want to proceed. This is to make sure that you do not inadvertently leave the base station out of service when you end a Service Kit session. Select **No** to cancel logging off or disconnecting, and then change the base station's mode back to Run before logging off or disconnecting.

Working with Different Versions

As time goes by, it is natural to end up with a system that has a mixture of versions. For example:

- A module fails and its replacement has a newer hardware version.
- New firmware offers a highly desirable feature so a module is upgraded.
- A new Service Kit version is released and is loaded on the PC.

When modules with different versions try to work together, compatibility problems can arise. The following offers some guidance.

Quick Tips

- A PC can only have one Service Kit version installed at a time. Ensure that upgrading the Service Kit does not make it incompatible with your base station equipment.
- A new Service Kit can only save a configuration in its own format, but it can program the information into an older base station.
- Version numbers are incremented when an update is made. Versions that are designed to work with each other don't necessarily have the same version number.
- For information about compatibility for particular versions, see the Release Notes (on the Product CD).

Replacing Modules

When replacing a PA, PMU, or reciter module, check the Release Notes to ensure that the module is compatible with the other modules in the subrack. (Hardware versions are on the module label. The Service Kit can display firmware versions).

Upgrading Firmware

You can use the Service Kit to upgrade the firmware of a base station module. The Service Kit will only let you select firmware versions that are compatible with each other and with the respective module's hardware version.

Upgrading the Service Kit

Before installing a version of the Service Kit from the product CD, check the compatibility table in the Release Notes to make sure that the Service Kit will be compatible with the base station modules' firmware and hardware versions.

Service Kit Handling of Older Versions

The Service Kit can handle older base stations and configuration files. Any differences are handled by conversion rules. The Service Kit applies these rules when reading from the base station, programming the base station, or opening a configuration file.

For example, the Service Kit Version 02.00 has a parameter "Revert to Run mode" and a timer value after which the reversion happens. When the Service Kit opens an older configuration file or reads an older base station, the conversion rules tell it to supply the default settings for the parameter and its value and displays them, even though they don't actually exist in the base station. When the Service Kit programs the configuration into an older base station, these settings are discarded, because the base station doesn't know about them. You are given no indication that this has happened. The base station continues to behave as before (it doesn't revert to Run mode).

Generally speaking, the application of conversion rules will not be noticed but could in some situations significantly alter base station behaviour. If you have any concerns, check the Release Notes for new features, enhancements, or fixed issues. These apply to the new Service Kit but not to older base station versions.

Upgrading Base Station Firmware

When you install the Service Kit, firmware for the different base station modules is copied into the firmware files folder (by default C:\Program Files\Tait Programming Applications\TB8100 Service Kit\FirmwareFiles). Older firmware versions and a compatibility file are also copied over. Firmware versions are also available from the Tait support website. Copy them into the firmware files folder.

You can use the Service Kit to upgrade the firmware of base station modules. The Service Kit uses the compatibility file to ensure that the new firmware will not lead to incompatibility. It is also possible to downgrade a module to an older firmware version to ensure compatibility with other base station modules.

To upgrade a base station's firmware

1. Copy the firmware files and the compatibility file into the Service Kit's firmware files folder (to find out where this folder is located, select Tools > Options).
2. Using a direct connection, connect to the BSS and log on to the base station as Administrator. Put the base station in Download mode.
3. Select Tools> Firmware Download. The Firmware Download dialog box appears.

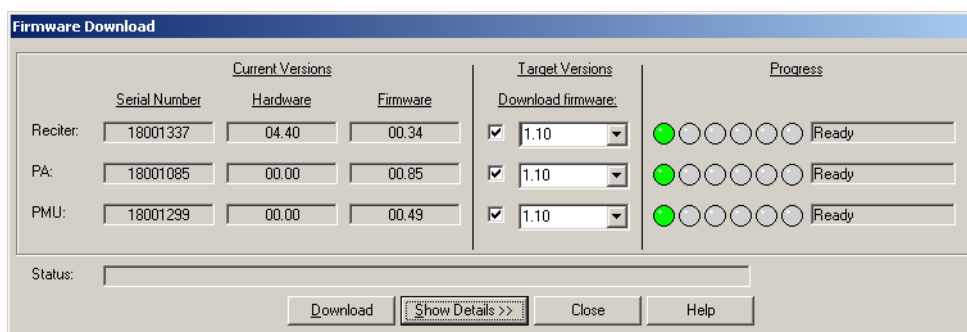

The Service Kit obtains information about the base station's modules and displays it in the Current Versions area. It then determines whether the new firmware is compatible with the base station's hardware. If it is, the version number of the new firmware appears in the Target Versions area. (To view the compatibility file and see what firmware versions are available, click **Show Details**.)

4. In the **Target Versions** area, select the check boxes of the modules you want to upgrade.
5. Make sure that the Progress area displays Ready for the modules you want to upgrade, and then click **Download**.

The Service Kit reads the base station's configuration information, stores it on disk, and then downloads firmware for the modules you selected. The Progress area indicates what is happening.



Note: When the PMU is being upgraded it can still provide power to the entire BSS, but it cannot control its fan or provide information about alarms, monitoring, or diagnostics.

If a step in the process is unsuccessful, you are given some options. You may be able to skip to the next module leaving the failure as is, restart the firmware download (this means going back to the Firmware Download form and trying again), or retry the step that failed. If necessary, contact Tait for assistance. It helps if you can provide the error log (this is stored in the LogFiles folder (see Tools > Options for its location)).

When all LEDs are green and the text box displays 'Done', the firmware upgrade has been successfully completed. The firmware has been downloaded and written to flash memory.

6. Wait while the Service Kit resets the base station and automatically logs on again. It checks that the base station is operating with the downloaded firmware versions, and then programs the stored configuration information back into the base station. It resets the base station again and automatically logs back on.
7. When the message Firmware Download Complete appears, return the base station to Run mode.

The base station is now operating with the new firmware.

Working with the Software Feature Enabler

The software feature enabler (Tools > Software Feature Enabler) lets you enable additional feature sets in the TB8100 base station. The base station already has these feature sets but it needs license keys to enable them. The software feature enabler also displays the status of all feature sets and lets you disable any that are enabled.

Feature Code	Feature Set	Status	Seq	Feature License Key
TBAS000	Default Radio System	Enabled	1	SHDN.K5ZL.GTNE.7T3F.7YBL.TD
TBAS010	Alarm Reporting	Enabled	1	PLUW.MLA7.9FVX.XTCF.7YBL.TD
TBAS020	Advanced Profiles and Task Manager	Enabled	1	WY8C.STSY.PBLY.2TVF.7YBL.TD
TBAS030	Power Saving Modes	Enabled	1	9GXL.DAHR.CSYS.NTLF.7YBL.TD
Reserved		Disabled	0	
Reserved		Disabled	0	
Reserved		Disabled	0	
Reserved		Disabled	0	

The form displays the name and reciter serial number of the base station you are connected to. Each row in the table displays information about a feature set: the Feature code used to order a feature set, its name, and whether it is enabled or disabled. The **Seq** column indicates how many times it has been enabled or disabled.

Enabling Additional Features

If you want a feature set, obtain a license key from Tait for that feature set, and then use the Service Kit to enable it.

To enable a feature set

1. Connect and log on to the base station with the Administrator access level.
2. If you received the license key in a license file, copy that file (and any others that you received for other feature sets or other base stations) to the Service Kit's license file folder (select Tools > Options to see which folder the Service Kit uses).
3. Go into Standby mode, and then select Tools > Software Feature Enabler.
4. Click the feature set to select it.
5. If you received a license file, click **Find License File**. This searches the license file folder for a license file for the current base station and the selected feature set. If the Service Kit finds one, it displays the license key (in the feature set's row and in the Feature License Key boxes), and increments the Seq column by 1.
6. If you don't have a license file, enter the license key into the Feature License Key boxes.

7. Click **Enable**. This enables the feature set. The license key appears in the feature set's row and the Seq column is incremented by 1.

Disabling a Feature Set

Feature sets are not normally disabled. However, disabling may be desirable in special circumstances, for example, if you are trying out the feature set and decide not to purchase it.

Disabling the Alarm Reporting Feature Set

You can only disable this feature set if the base station does not use it.



Important: A disabled feature set can only be re-enabled by purchasing a new license key. The original feature license key cannot be re-used.

1. Check the **Reciter Serial Number** box to make sure that you are logged on to the correct base station.
2. Make sure that communications with the Alarm Center (Configure > Communications > Alarm Center) and communications using email (Configure > Communications > Email) are disabled.
3. Go into Standby mode.
4. Select Tools > Software Feature Enabler.
5. Select the feature set's row.
6. Click **Disable**.

The progress bar indicates how far the disabling has progressed. On completion, a new number appears in the **Feature License Key** column. Communicate this new number to Tait if you are entitled to a refund or if you want to re-enable the feature set.

Disabling the Advance Profiles and Task Manager Feature Set

You can only disable this feature set if the base station does not use it.



Important: A disabled feature set can only be re-enabled by purchasing a new license key. The original feature license key cannot be re-used.

1. Check the **Reciter Serial Number** box to make sure that you are logged on to the correct base station.
2. Make sure that no channels use customized channel or signalling profiles. (In other words, they all use default profiles.)
3. Make sure that there are no more than 20 enabled task manager tasks. The number of enabled Task Manager tasks is displayed in all Task Manager forms. If necessary, disable unneeded tasks until the total number is 20 or less.
4. Go into Standby mode.
5. Select Tools > Software Feature Enabler.
6. Click the feature set's row.
7. Click **Disable**.

The progress bar indicates how far the disabling has progressed. On completion, a new number appears in the **Feature License Key** column. Communicate this new number to Tait if you are entitled to a refund or if you want to re-enable the feature set.

Disabling the Power Saving Modes Feature Set

You can only disable this feature set if the base station does not use it.



Important: A disabled feature set can only be re-enabled by purchasing a new license key. The original feature license key cannot be re-used.

1. Check the **Reciter Serial Number** box to make sure that you are logged on to the correct base station.
2. Make sure that all channel profiles have Sleep and Deep Sleep modes disabled.
3. Go into Standby mode.
4. Select Tools > Software Feature Enabler.
5. Select the feature set's row.
6. Click **Disable**.

The progress bar indicates how far the disabling has progressed. On completion, a new number appears in the **Feature License Key** column. Communicate this new number to Tait if you are entitled to a refund or if you want to re-enable the feature set.

Disabling the Default Radio System Feature Set

If the Default Radio System feature set is disabled, the base station cannot operate in Run mode. You can configure it, monitor it, and carry out diagnostic tests on it, but not use it as a base station. It is suitable for training purposes only.



Important: A disabled feature set can only be re-enabled by purchasing a new license key. The original feature license key cannot be re-used.

1. Check the **Reciter Serial Number** box to make sure that you are logged on to the correct base station.
2. Go into Standby mode.
3. Select Tools > Software Feature Enabler.
4. Select the feature set's row.
5. Click **Disable**.

The progress bar indicates how far the disabling has progressed. On completion, a new number appears in the **Feature License Key** column. Communicate this new number to Tait if you are entitled to a refund or if you want to re-enable the feature set.

Part D Monitoring

The Service Kit lets you monitor the TB8100 base station. It can provide details about each module and monitor the level of incoming and outgoing signals. The Service Kit can also display the base station's log. Monitoring can take place while the base station is in Run mode; it has no effect on base station operation.

The Service Kit also shows you whether any alarms are active. You can view the status of all alarms or a list of recent alarms. See ["Alarms" on page 131](#).

To monitor a base station, log on to it, click **Monitor**, and select an item from the navigation pane.

Topics

- [Module Details](#)
- [Operational Information](#)
- [Viewing System Data](#)

Module Details

The Service Kit can display details about the [reciter](#), [PA](#), and [PMU](#) of the base station you are logged on to. Items under the heading Module Details give you information about the module such as its frequency range and firmware version. To monitor the way the base station is operating, see “[Operational Information](#)” on page 63.

Viewing Reciter Information

The Reciter form (Monitor > Module Details > Reciter) lets you view information about the [reciter](#) module of the base station you are logged on to. Use it to confirm exactly what it is that you are dealing with.

The screenshot shows a web form titled "Reciter" with the following fields:

Module:	Reciter 1	Alarm status:	<input checked="" type="checkbox"/> No Alarms active
Product Code:	TBA40H2-0B0	Serial number:	18001340
Band:	440 - 480MHz		
Receiver setting:	446.5 - 456.5MHz		
Exciter setting:	446.5 - 456.5MHz		
System interface:	Isolated 25		

Below this is a section titled "Versions" with the following fields:

Hardware:	04.40		
Firmware:	00.34		N/A
Calibrated:	N/A		
System Interface:	0		

The form has several read-only fields, an LED indicating whether there are any reciter alarms, and an area that gives version information.

Module	The name of the module (reciter) followed by a number. This number is set by the rotary switch on the front of the reciter and plays a role in control bus communications within the BSS.
Product code	The product code and name for the type of reciter.
Band	The RF frequency band of the reciter. This is the frequency range that the reciter is type-approved to operate in.
Receiver setting	The current switching range of the receiver. This can be changed using the Calibration Kit.
Exciter setting	The current switching range of the exciter. This can be changed using the Calibration Kit.
System interface	The type of system interface card that the reciter is fitted with.

Alarm status	Indicates whether the reciter currently has any alarm conditions. If the LED is green, there are no active reciter alarms. If the LED is red, the text box displays 'Alarms active,' and there is at least one active alarm. To see which alarm is active, select Monitor > Alarms > Current Status.
Serial number	A unique identifier assigned to the reciter in the factory.

Versions

The Versions area (Monitor > Module Details > Reciter) displays version numbers for aspects of the reciter.

Hardware	The version number of the reciter's hardware.
Firmware	The version number of the reciter firmware and its creation date.
Calibrated	The date when the reciter was last modified using the Calibration Kit. (This includes adjusting the switching range and tuning the frequency response.)
System interface	The version number of the system interface board installed in the reciter.

Viewing Power Amplifier Information

The Power Amplifier form (Monitor > Module Details > Power Amplifier) lets you view information about the PA module of the base station you are logged on to. Use it if you need to confirm exactly what it is that you are dealing with.

The screenshot shows a web-based configuration form for a Power Amplifier. The form is titled 'Power Amplifier' and contains several input fields and a status indicator. The 'Alarm status' field shows a green LED icon and the text 'No Alarms active'. The 'Serial number' field contains '18001315'. Below these fields is a section titled 'Versions' which contains three rows: 'Hardware' with '00.00', 'Firmware' with '00.85' and 'N/A', and 'Calibrated' with '25-Mar-03'.

Module	The name of the PA. This non-editable name is used internally to identify the PA.
Product code	The product code and name for the type of PA.
Band	The RF frequency range that the PA is type-approved to operate in.

Power	Specifies the RF power output rating of the PA. There are 5 W, 50 W, and 100 W variants.
Isolator	Indicates whether the PA is fitted with an optional isolator .
Alarm status	Indicates whether the PA currently has any alarm conditions. If the LED is green, there are no active alarms. If the LED is red, the text box displays 'Alarms active,' and there is at least one active alarm. To see which alarm is active, select Monitor > Alarms > Current Status.
Serial number	A unique identifier assigned to the PA in the factory.

Versions

The Versions area (Monitor > Module Details > Power Amplifier) displays version numbers for aspects of the PA.

Hardware	The version number of the PA hardware.
Firmware	The version number of the PA firmware and the date when the PA was updated to its current firmware.
Calibrated	The date when the PA was last calibrated using the Calibration Kit.

Viewing Power Management Unit Information

The Power Management Unit form (Monitor > Module Details > Power Management Unit) lets you view information about the PMU of the base station you are logged onto. Use it if you need to confirm exactly what it is that you are dealing with.

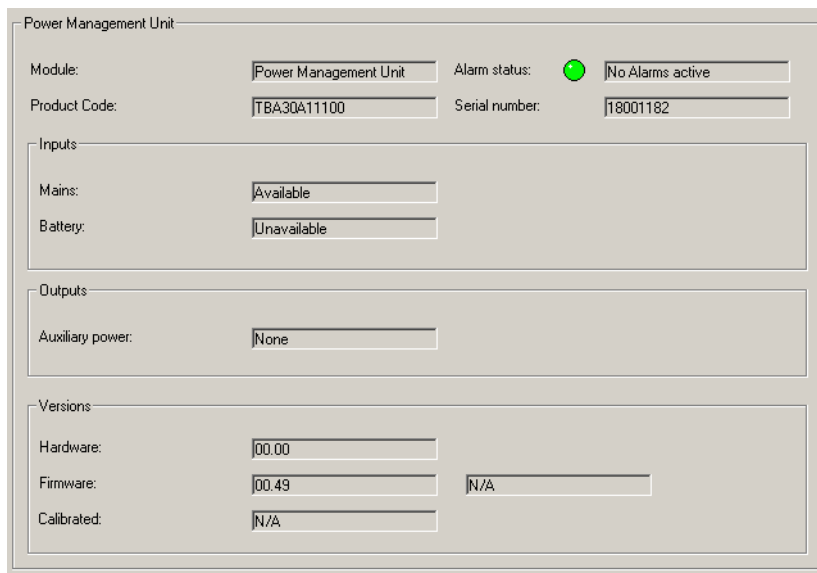

The screenshot shows a web-based form titled "Power Management Unit". It contains several sections with input fields and status indicators:

- Module:** Power Management Unit
- Product Code:** TBA30A11100
- Alarm status:** No Alarms active (indicated by a green LED icon)
- Serial number:** 18001182
- Inputs:**
 - Mains:** Available
 - Battery:** Unavailable
- Outputs:**
 - Auxiliary power:** None
- Versions:**
 - Hardware:** 00.00
 - Firmware:** 00.49
 - Calibrated:** N/A

Module	The name of the PMU. This non-editable name is used internally to identify the module on the rack frame bus.
Product code	The product code and name of the PMU module.

Alarm Status Indicates whether the PMU currently has any alarm conditions. If the LED is green, there are no active alarms. If the LED is red, the text box displays 'Alarms active,' and there is at least one active alarm. To see which alarm is active, select Monitor > Alarms > Current Status.

Serial number A unique identifier assigned to the PMU in the factory.

Inputs

The Inputs area (Monitor > Module Details > Power Management Unit) indicates which inputs the PMU is able to use.

Mains 'Available' indicates that the PMU is fitted with an AC-DC converter submodule. It can use mains input.

Battery 'Available' indicates that the PMU is fitted with a DC-DC converter submodule. It can use DC power as an input.

Outputs

The Outputs area (Monitor > Module Details > Power Management Unit) indicates whether the PMU is able to supply an optional output.

Auxiliary power 'Available' indicates that the PMU is fitted with an auxiliary power supply submodule. It can provide an output for auxiliary equipment or for charging the batteries.

Versions

The Versions area (Monitor > Module Details > Power Management Unit) displays version numbers for aspects of the PMU.

Hardware The version number of the PMU hardware.

Firmware The version number of the PMU firmware and its creation date.

Calibrated Indicates when the PMU was last calibrated using the Calibration Kit.

Operational Information

The Service Kit can monitor the base station's current settings and the way the reciter, PA, and PMU are operating. You must be logged in to that base station. Click Monitor, and then choose one of the items under Monitoring. To display information about the modules themselves, see [“Module Details” on page 59](#).

Monitoring the Current Channel

The Channel form (Monitor > Monitoring > Channel) displays information about the channel that the base station is currently operating on.

The screenshot shows a web-based form titled "Channel" with the following sections and values:

- Current channel:**
 - Channel number: 1
 - Channel name: Channel 001
 - Rx frequency: 450.965000
 - Tx frequency: 450.505000
- Channel profile:**
 - Profile name: Channel Pro 1
 - Filter: Flat Full Band
 - Output power: 50W
 - Channel spacing: 20kHz
- Signalling profile:**
 - Profile name: Default
 - Receive signalling: None
 - Transmit signalling: C 218.1 Hz
- Current source:**
 - Channel source: Hardware
 - Clock reference: Internal

The Current channel area specifies which channel is current and displays its most important details.

The Channel profile and Signalling profile areas display information about the profiles assigned to the current channel.

The Current source area tells you whether the channel was selected by software (the Service Kit) or by hardware (external channel selection lines). If an external reference source is connected, it tells you what frequency the base station expects.

Current Channel

The Current channel area (Monitor > Monitoring > Channel) displays details about the [channel](#) that the base station is currently using. The **Channel number** and **Channel name** boxes identify the channel. The **Rx frequency** box indicates the frequency that the base station is receiving on and the **Tx frequency** box indicates the frequency that it transmits on. Channels are created in Configure > Base Station > Channel Table.

Profile Information

The **Signalling profile** and **Channel profile** areas (Monitor > Monitoring > Channel) indicate which profiles have been assigned to the channel and display information about them. This information is the same as appears in the channel table.

Current Source

The Current source area (Monitor > Monitoring > Channel) indicates what selected the current channel and which source provided the reference frequency.



Note: The current source's choice of channel can be overridden by [Task Manager action](#).

Channel source

The Channel source box indicates whether hardware or software selected the current channel.

Option	Description
Hardware	The channel number was selected externally using equipment that is connected to channel selection lines on the base station's external interface. Hardware channel selection is enabled in Configure > Base Station > System Interface.
Software	The channel number was selected by software. The channel number is the default channel (set by the Service Kit in Configure > Base Station > General).

Clock reference

The Clock reference box indicates what is providing the base station with a reference frequency (from which it derives the channel frequencies).

Option	Description
Internal	The base station's own clock signal is the reference source.
External	External equipment is providing the reference source via a BNC connector at the rear of the reciter. The Service Kit must tell the base station whether to expect 12.8 or 10 MHz (Configure > Base Station > Miscellaneous).

Monitoring the Reciter

The Reciter form (Monitor > Monitoring > Reciter) lets you monitor the [RSSI](#) and [SINAD](#) of the received signal and the audio levels on the input and output lines. Each level is displayed graphically as a gauge. The equivalent numeric value appears under the gauge heading. If the value is red, it has exceeded the maximum or fallen below the minimum that the gauge can display.



The first box in the form displays the internal name of the reciter.

Alarm status	The Alarm status box indicates whether the reciter has an alarm. If the LED is red, select Monitor > Alarms > Current Status to see which alarm is active.
Received signal	The Received signal area displays the RSSI and SINAD levels. (If you want to know the equivalent RSSI in microvolts, see “Converting Between Microvolts and dBm” on page 80). The SINAD is only an approximation.
Input lines	The Input lines area displays the audio levels for the balanced and unbalanced line inputs.
Output lines	The Output lines area displays the audio levels for the balanced and unbalanced line outputs.
Rx Gate output	The Rx Gate output LED displays the current state of the Rx Gate line. If it is green (active), the base station is receiving a valid signal.
Tx Key input	The Tx Key input LED displays the current state of the Tx Key line. If it is green (active), the line has been asserted, instructing the base station to transmit.

Monitoring the Power Amplifier

The Power Amplifier form (Monitor > Monitoring > Power Amplifier) lets you monitor the levels of various parameters. Each level is displayed graphically as a gauge or thermometer. The equivalent numeric value appears in or under the heading. If a value goes off the scale, it turns red.

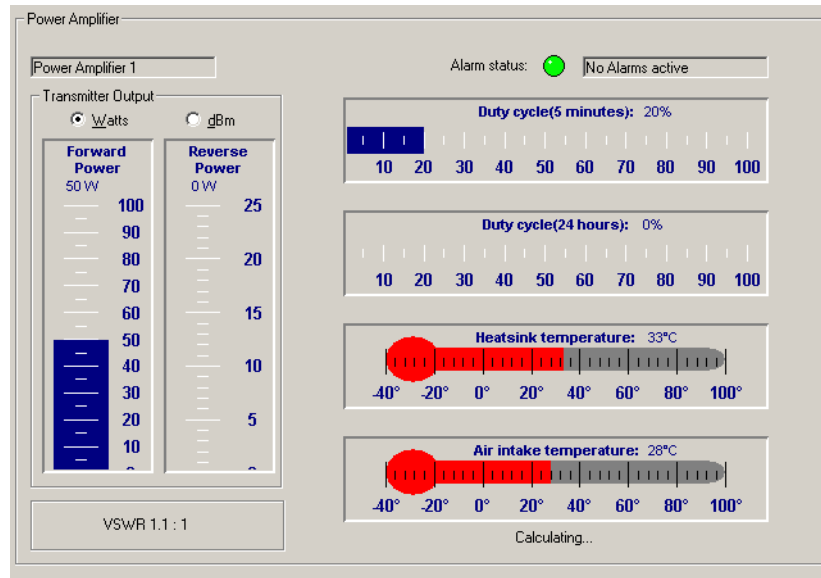

The first box in the form displays the internal name of the PA.

Alarm status	The Alarm status box indicates whether the PA has an alarm. If the LED is red, select Monitor > Alarms > Current Status to see which alarm is active.
Transmitter output	The Transmitter output area displays the forward and reverse power. Click Watts or dBm to view these parameters as watts or dBm. Underneath is the VSWR . If the VSWR is greater than 10:1, an alarm is triggered and the PA folds its output back to 10% of its capability. Only when the VSWR falls below 5:1 will the power output begin to recover.
Duty cycle (5 minutes)	Indicates the average duty cycle over the past 5 minutes. This parameter is updated once every minute. 50% means that the PA was transmitting for 2.5 of the last 5 minutes.
Duty cycle (24 hours)	Indicates the average duty cycle over the past 24 hours. 25% means that the PA was transmitting for 6 of the last 24 hours.
Heatsink temperature	Displays the highest of the three temperatures measured at the PA driver, Final 1, and Final 2 transistors.
Air intake temperature	This thermometer displays the temperature measured at the air intake to the PA heatsink.

Monitoring the Power Management Unit

The Power Management form (Monitor > Monitoring > Power Management) lets you monitor the operation of the PMU. You can:

- Check the voltage of the battery and the current that the PMU outputs to the PA.
- See whether the base station is running on battery or mains power.
- Check the status of the PMU's inputs and outputs.

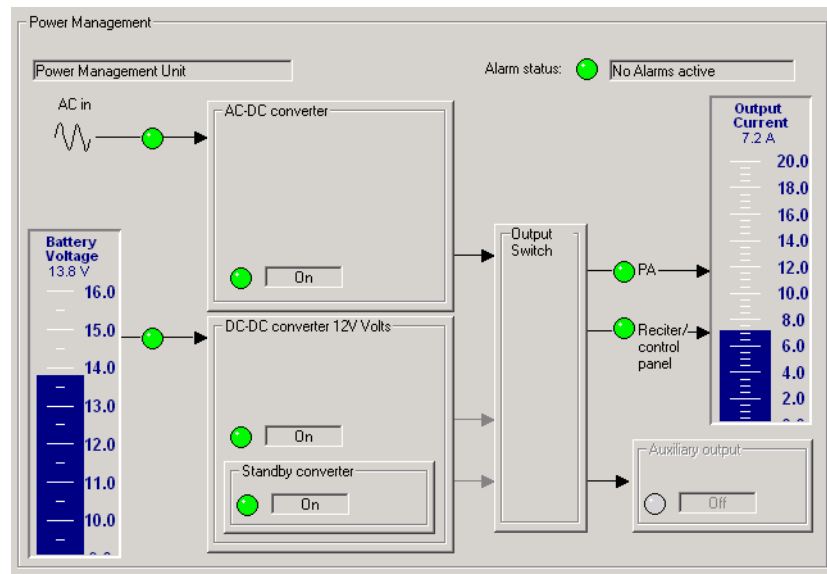

This form has a gauge displaying the battery voltage and another displaying the output current. Boxes represent different PMU submodules and LEDs indicate the status of power inputs and outputs. A box is disabled if the equivalent submodule is not installed.

The first box in the form displays the name of the module: power management unit.

Alarm status

The Alarm status box indicates whether there is a current alarm. If the LED is red and the box displays 'Alarms active', one or more PMU alarms have been triggered. Select Monitor > Alarms > Current Status to see which alarms are active.

Battery voltage gauge

The battery voltage gauge indicates the voltage of the DC power supply to the PMU (whether or not it is currently being used).

Power inputs

LEDs in the boxes in the middle of the form indicate the status of the different power inputs.

AC-DC converter The LED in the AC-DC Converter box indicates the state of AC power.

LED	Text	Description
Green	On	AC power input is usable
Red	Off	AC power input is too low or too high
Gray	Off	Mains Failure test is running

The box label indicates the voltage the DC-DC converter is designed for (12, 24, or 48 V).

DC-DC converter The LED in the DC-DC converter box indicates the state of the battery input, whether or not that input is currently being used.

LED	Text	Description
Green	On	Battery input is usable. The PMU can provide up to 500 W (or up to 40 W of power in low power mode).
Red	Off	Battery voltage is too low or too high.
Gray	Off	No battery power supply is fitted (the box is also disabled).

Standby converter The LED in the Standby converter box indicates the state of the DC supply to the standby converter. This submodule operates only when the PMU enters deep sleep mode, in which it provides power only to the reciter.

LED	Text	Description
Green	On	The standby DC supply has been turned on. The PMU is providing only 10 W of power to the exciter.
Red	Off	Battery voltage is too low or too high.
Gray	Off	No standby battery power supply is fitted.

Power outputs

The right-hand side of the form displays information about the PMU's power output to other TB8100 equipment in the rack frame.

There are three arrows going into the Output switch box. The one that is not disabled indicates which converter is currently providing power

PA The PA LED displays green if the PMU is supplying power to the PA and gray if it is not. When the PMU is using mains power, it always supplies power to the PA. When it is using battery power, it supplies power unless it is in sleep mode and using the standby converter.

Reciter/control panel The Reciter/control panel LED indicates the status of the power supply to the receiver and the control panel. Green means that it is supplying power. Gray means that it is not, because the PMU is in battery protect mode.

Auxiliary output

The Auxiliary output box has an LED that indicates the status of the auxiliary power or battery charging output.

LED	Text	Description
Green	On	The standby DC supply has been turned on. The PMU is providing only 10 W of power to the exciter.
Red	Off	There is a fault. This could be because there has been a current overdraw and the fuse is blown. On cooling, the fuse will automatically reset.
Gray	Off	No auxiliary power supply unit is fitted or the PMU has turned the output off.

The box label indicates the voltage that the auxiliary power submodule is designed to produce (12, 24, or 48 V).

Output Current gauge

The Output Current gauge shows how much current the PMU is supplying to the rest of the BSS.

Viewing System Data

The base station stores data about its own operation. It keeps count of some items, records the maximum or minimum value of others, and also calculates some averages. Averages are rolling averages over the last 24 hours. For example, the base station stores the highest temperature that the PA has reached and it adds up the total number of hours that the fan has been operating for. You can view this information in the System Data form (Monitor > Data Logging > System Data).

The **Resetable** and **Permanent** option buttons give you the choice of two sets of data. These sets are rather like the trip meter and the odometer of a car. Click **Permanent** to display the permanent data set. This data set is maintained for the whole life of the base station and can only be reset by authorised service centers, for example after repairs to a module.

Click **Resetable** to display the ‘trip meter’ set of data. With administrator access, you can reset any or all of the data.

Reset buttons let you reset an individual parameter and the **Reset All** button resets all system data values. These buttons are disabled when you view the permanent set of values, unless you are logged on as a service center. If you reset a counter, it starts counting again from zero. If you reset a maximum, average, or minimum, it initially displays the current parameter value.

Base Station Data

The Base station area (Monitor > Data Logging > System Data) displays the following data.

Base station operating time	The number of hours that the base station has been powered up and operating in Run, Standby, or Download mode.
Transmitter duty cycle	The percentage of the operating time that the base station has actually been transmitting.

VSWR	The highest, the average, and the minimum voltage standing wave ratio readings are shown. The base station reads the VSWR once in every transmission.
RSSI	The highest, the average, and the minimum RSSI readings are shown in dBm. The base station reads the RSSI once each time the base station receives a valid signal.
Watchdog resets	The total number of times that the watchdog circuit reset the reciter because the reciter firmware locked up.
Task Manager resets	The total number of times that Task Manager reset the base station.
Service Kit resets	The total number of times that Service Kit users reset the base station.

Power Amplifier Data

The Power Amplifier area (Monitor > Data Logging > System Data) displays the following data.

Temperature	The Power Amplifier area displays maximum, average, and minimum temperatures. The maximum temperature is the highest maximum temperature recorded by any of the three PA temperature sensors. These temperatures are read hourly.
Air intake temperature	The Power Amplifier area displays maximum, average, and minimum air intake temperatures. The air intake temperature is read hourly.
PA fan operating time	The number of hours that the PA fan has been operating.

Power Management Unit Data

The Power Management Unit area (Monitor > Data Logging > System Data) displays the following data.

Battery voltage	The area displays maximum, average, and minimum battery voltages. The battery voltage is read hourly whether or not the PMU is using the battery as its power supply.
PMU fan operating time	The number of hours that the PMU fan has been operating.

Part E **Configuring the Base Station**

The Service Kit lets you configure the TB8100 base station.

Click **Configure**, and select an item from the navigation pane.

For information about configuring channels and their profiles, see [“Configuring Channels” on page 87](#).

Topics

- [Choosing a Configuration](#)
- [Configuring General Options](#)
- [Configuring the System Interface](#)
- [Configuring Fan Control](#)
- [Configuring Miscellaneous Items](#)
- [Printing a Base Station Configuration](#)

Choosing a Configuration

If you click **Configure** and the Service Kit doesn't already have a configuration loaded, it asks you to choose one to work with.

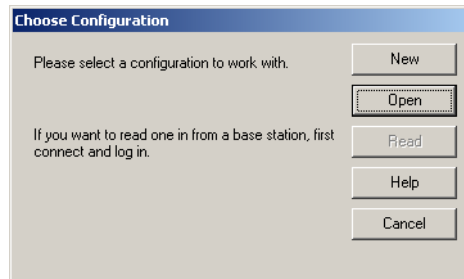

- Click **New** to open a new configuration based on the default template.
- Click **Open** to select an existing configuration file.
- Click **Read** to read a base station's configuration. You may need to connect to a BSS and log in to a base station first.

Configuring General Options

The General form (Configure > Base Station > General) names the base station and specifies the default channel. From this form, you can customize the default channel and signalling profiles. A panel on the right gives you high-level instructions on how to configure channels in a simple system.

The screenshot shows a software window titled "General". It is divided into several sections. On the left, there is an "Identification" section with a text box for "Base Station name" containing "Mount John No 1". Below that is a "Default profiles" section with two buttons: "Channel Profile" and "Signal Profile". At the bottom left is a "Default channel" section with a drop-down menu showing "2 - Channel 002". On the right side, there is a "Channel Configuration quick start" panel with a list of four steps: 1. Edit the default channel profile to suit your system. 2. Do the same for the default signalling profile. 3. Select Configure > Base Station > Channel Table and edit the first channels frequencies, then block copy it to set up all the channels you need. 4. Return to this form and select one of the channels as the default channel. At the bottom of the window are "OK" and "Cancel" buttons.

Identification

Specifies the name of the base station. Enter a suitable name. This name is used in the Log On form to help you select the correct base station within the BSS. You may need to disconnect and turn the base station off, and then turn the base station on again and re-connect, before a new name appears in the log on window and on the status bar.

Default profiles

Lets you configure default profiles. Click **Channel Profile** or **Signal Profile** to open the editing dialog box for the corresponding default profile.

Default channel

Specifies the default channel. Select a channel from the drop-down list to make it the default channel (see [“Default Channel” on page 5](#)). The drop-down list contains all the channels that have been defined in the channel table (Configure > Base Station > Channel Table). Each entry in the list contains a channel number followed by the corresponding channel name.

Configuring the System Interface

The System Interface form (Configure > Base Station > System Interface) lets you configure the base station's system interface.

Pin	Description
1	Rx Line +
2	Rx Line -
3	Rx Audio
4	Audio Ground
5	Tx Audio
6	Tx Line +
7	Tx Line -
8	RSSI
9	Rx Gate
10	Tx Key
11	Digital Out 1
12	Digital Out 2
13	Aux+ Out
14	Channel Selection (Bit 0)
15	Channel Selection (Bit 1)
16	Digital In 3
17	Digital In 4
18	Digital In 5
19	Digital In 6
20	Digital In 7
21	Digital In 8

Simple repeater applications do not require any interface.

The form displays the pin assignments and other information for the selected system interface. It lets you configure the [RSSI](#) output line and the external channel selection lines.

Viewing System Interface Details

You can view the pin assignments for the system interface.

1. Log on to the base station and select Monitor > Module Details > Reiter to find out which system interface is fitted.
2. Select Configure > Base Station > System Interface.
3. In the **Type** list, select the system interface that has been fitted.

The table underneath the **Type** box now shows you the pin assignments for that system interface. The pin assignments will update to reflect any changes you make to external channel selection. See [“Configuring External Channel Selection”](#) on page 77.

Configuring External Channel Selection

Usually, the channel that the base station normally operates on is selected using the Service Kit (see [“Default channel”](#) on page 76). If you want the channel to be selected by equipment external to the base station, enable external channel selection and configure the base station's system interface to reflect the way that equipment works.

To configure external channel selection

1. Select Configure > Base Station > System Interface.
2. Select the **Channel selection** check box. This enables external channel selection.
3. In the **Pins to use** box, select an option. For each bit in the binary channel number, you need a pin.

The table to the left updates to indicate which pins are for channel selection and the **Number of selectable channels** box updates to indicate the highest channel number that the hardware will be able to select.

4. Specify whether the external equipment selects the channel number using binary or [BCD](#) format.



Important: The base station interprets a line as ‘1’ when it is active (when the external equipment is pulling it to ground, the voltage is low, and current is flowing).

5. If the external equipment pulls a line to ground to indicate a ‘0’, select the **Invert** box.
6. Use the Service Kit to test your setup. See “[Testing Hardware Channel Selection](#)” on page 162.



Note: Setting the channel to 000 (by switching all DIP switches off—or on, if the selection is inverted) disables external channel selection. The base station will operate on the channel selected by the Service Kit or by [Task Manager action](#).

Configuring RSSI Output

If your system has equipment external to the base station that needs an [RSSI](#) voltage, you can configure that voltage to suit the equipment.

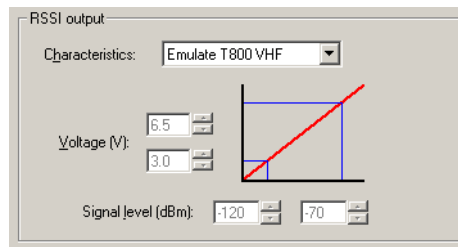

If the equipment is configured to operate with older Tait base stations, you can specify that the RSSI output behaves like the output from a Tait T800 VHF or UHF base station.

For other equipment, specify the maximum and a minimum output voltage that your equipment expects, and the maximum and minimum signal strengths that the base station needs to deal with. The base station will then map the signal strength range to the output voltage range. When it receives a valid signal, it outputs an RSSI voltage based on the strength of that signal.



Tip: Alternatively, leave the RSSI output as it is and adjust the external equipment to work with that output. Use the RSSI output test when making the adjustment (Diagnose > Reciter > Misc I/O).

To configure the RSSI output

1. Select Configure > Base Station > System Interface.
2. If your equipment is configured to work with Tait T800 equipment, in the **Characteristics** box, select Emulate T800 VHF or Emulate T800 UHF. This sets the parameters for the RSSI output. Otherwise, select User Defined and continue.
3. In the **Voltage** boxes, set the maximum and minimum voltages that the RSSI output will provide when the received signal varies from maximum to minimum.
4. In the **Signal level** boxes, specify the received signal strengths in dBm to correspond to the minimum and maximum voltages. (If you work in microvolts, see [“Converting Between Microvolts and dBm”](#) on page 80.)

When the signal strength reaches the lower value, the RSSI output line will have the minimum voltage. As the received signal strength increases, the voltage will increase linearly. When the received signal strength reaches the upper value, the RSSI output line will have the maximum voltage. Further increases in signal strength will not significantly increase the RSSI voltage.

Converting Between Microvolts and dBm

The following table lets you convert displayed levels in dBm into microvolts.

Level in Microvolts	Level in dBm	Level in Microvolts	Level in dBm
0.10	-126.99	10.00	-86.99
0.20	-120.97	12.50	-85.05
0.25	-119.03	15.00	-83.47
0.30	-117.45	17.50	-82.13
0.40	-114.95	20.00	-80.97
0.50	-113.01	30.00	-77.45
0.60	-111.43	40.00	-74.95
0.80	-108.93	50.00	-73.01
1.00	-106.99	60.00	-71.43
1.50	-103.47	70.00	-70.09
2.00	-100.97	80.00	-68.93
2.50	-99.03	90.00	-67.90
3.00	-97.45	100.00	-66.99
4.00	-94.95	150.00	-63.47
5.00	-93.01	200.00	-60.97
7.50	-89.49	250.00	-59.03

Configuring Fan Control

The Fan Control form (Configure > Base Station > Fan Control) gathers together fan-related settings.

PA Fan Control

The PA Fan Control area determines when the PA fan is turned on. The settings can be adjusted to meet user requirements based on the transmit duty cycle and whether the site facility is air-conditioned. Strike a balance between lengthening fan life and reducing the PA operating temperature. The settings you choose should also help avoid extreme temperature swings. Bear in mind that the PA is designed to run at full duty cycle at up to +60°C ambient operating temperature into any transmit VSWR load.



Note: While the PA fan on/off thresholds are user-configurable, the PMU fan has fixed on/off thresholds controlled by the PMU firmware.

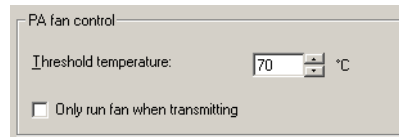

Threshold temperature

If the temperature at the driver, final 1, or final 2 stages exceeds the threshold temperature, the fan is turned on (but only when the PA is transmitting, if the check box below is selected). When the temperature at all three parts of the PA falls 5°C below the threshold, the fan is turned off.



Tip: To monitor all PA temperature values, select Diagnose > Power Amplifier > Control Tests.

Only run fan when transmitting

When this check box is selected, the fan will only operate if the PA is transmitting and any one of the monitored PA temperatures exceeds the threshold.

Emulating T800 Fan Operation

In Tait T800 series base stations, the fan is usually turned on and off based on the state of the transmitter's RF output. To emulate this, follow these steps:

1. Select Configure > Base Station > Fan Control.
2. Set the threshold temperature to a value that is lower than the usual site ambient temperature.
3. Select the Only run fan when transmitting check box.

With these settings, the PA fan turns on with RF output and cools the PA as soon as it begins working. It turns off when the RF output stops. The PA does not turn on if its temperature is below the threshold. This is an improvement compared with the T800 and lengthens fan bearing life.

Fans

The Fans area specifies how the base station monitors its fans.

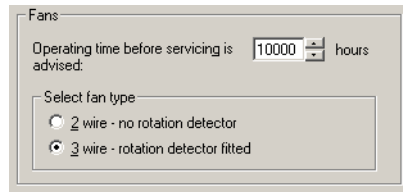

Fans

Operating time before servicing is advised: 10000 hours

Select fan type

2 wire - no rotation detector

3 wire - rotation detector fitted



Note: Fans used in the TB8100 must have the correct wiring. Power and ground (2-wire fans) or power, ground and rotation detect (3-wire fans). Both fans in a subrack should be of the same type.

To configure the monitoring of fans

1. Select Configure > Base Station > Fan Control.
2. In the Fans area, specify a number of fan operating hours. When the PA or PMU fan has actually been operating for this total length of time, the Task Manager input **PA fan servicing advised** or **PMU fan servicing advised** becomes true.
3. Create appropriate Task Manager tasks to define how you want to be notified when a fan needs servicing. For example, Task Manager could start over-the-air pips.
4. Specify whether the fan type is 2-wire or 3-wire. If you select 3-wire, the base station will use the third wire as a rotation detector. If it has turned the fan on but does not detect rotation, it activates the 'Fan failed' alarm.

Configuring Miscellaneous Items

The Miscellaneous form (Configure > Base Station > Miscellaneous) gathers together a number of settings.

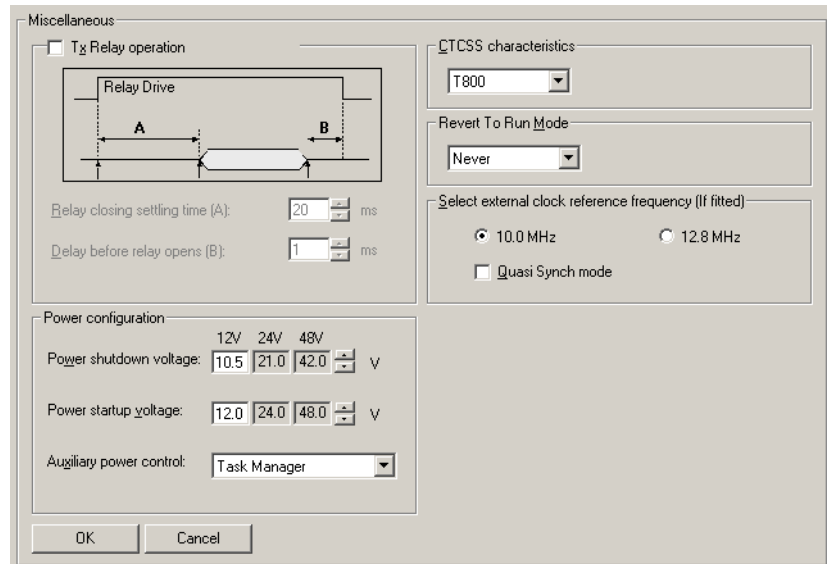

Tx relay operation

The Service Kit lets you enable the control of an antenna relay and configure its operation. The base station's reciter must be fitted with a system interface board that has a Tx Relay Driver line for connecting to the antenna relay (see Configure > Base Station > System Interface for pinout information).

Antenna relays (also known as coaxial relays) are used in simplex applications. Before the transmitter keys up, the base station activates the relay, disconnecting the receiver and connecting the transmitter to the antenna. It waits for the 'relay closing settling time', and then powers the transmitter up. After it powers the transmitter down, it waits for the 'delay before relay opens', and then opens the relay.

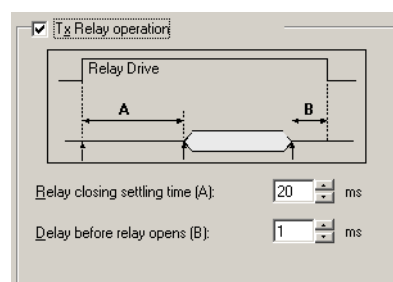

To enable and configure the operation of an antenna relay

1. Select Configure > Base Station > Miscellaneous
2. Select the **Tx relay operation** check box.

- Adjust the values of the **Relay closing settling time (A)** and the **Delay before relay opens (B)** boxes to reflect the expected delays in switching the relay.

Minimum battery voltage

The Power configuration area (Configure > Base Station > Miscellaneous) defines the lowest possible voltage for the DC power input to the PMU.

	12V	24V	48V
Power shutdown voltage:	10.5	21.0	42.0
Power startup voltage:	12.0	24.0	48.0
Auxiliary power control:	Task Manager		

Three pairs of voltages are displayed, corresponding to the PMU's different DC-DC converter options (a nominal 12 V, 24 V, or 48 V input). The voltages that apply have a white background and can be edited. If there is no AC power and the battery voltage falls below the value in the relevant **Power shutdown voltage** box, the BSS shuts down. If the voltage rises above the value in the **Power startup voltage** box and the PMU is fitted with a standby module, the BSS re-starts.



Important: The values you define in this area affect any other base stations in the BSS.

Auxiliary power control

If the PMU is fitted with an auxiliary power supply unit, you need to configure it to suit the way it will be used. Generally, its output can be used to charge batteries or to power other site equipment. This equipment can include TaitNet trunked modules. These can be powered via the reciter's system interface board (additional connection required).



Caution: *While the auxiliary power output can be used for more than one purpose at once, this is not generally recommended. It can result in a short-circuit and equipment damage. The output is floating. If it is connected to a negatively earthed battery and to positively earthed auxiliary equipment, a short-circuit will result.*

In the Power configuration area (Configure > Base Station > Miscellaneous), the Aux power control box specifies what controls the auxiliary output. Select one of the following options.

Option	Description
Task Manager	Task Manager tasks turn the output on or off. You need to define suitable tasks for your system and application so that the auxiliary power output is turned on when it is needed.
Mains	Output is provided only when the PMU uses mains power. This option is suitable for re-charging the batteries used for the PMU's DC power input.

CTCSS characteristics

The CTCSS characteristics area (Configure > Base Station > Miscellaneous) lets you globally configure CTCSS subaudible signalling to emulate the T800 or to follow the TIA/EIA603 standard.

Option	Detection time	Detect bandwidth	Reject bandwidth
T800	< 150 ms	2 Hz	3 Hz
EIA603	120 – 250 ms (for 250 – 67 Hz)	1.8%	3%

Reverting to Run mode

You can configure the base station to automatically revert to Run mode. This is recommended if Service Kits will remotely connect to the base station over unreliable communication lines.

In the Power configuration area (Configure > Base Station > Miscellaneous), select one of the following options for the Revert to Run mode box.

Option	Description
Never	The base station does not revert to Run mode. Service Kit users must manually put the base station back into Run mode before disconnecting. You are warned if you try to disconnect when the base station is still in Standby mode.
2 minutes	The base station automatically reverts to Run mode two minutes after the Service Kit disconnects.
10 minutes	The base station automatically reverts to Run mode ten minutes after the Service Kit disconnects.

Select external clock reference frequency (if fitted)

The Select external clock reference frequency (if fitted) area (Configure > Base Station > Miscellaneous) lets you specify the frequency of an external reference frequency source. If an external source is connected to the reciter, select the appropriate option to tell the base station what the source's frequency is.

Quasi Synch mode If the base station is part of a simulcast system, select the Quasi Synch mode check box. This changes the characteristics of the transmit synthesiser and reduces the maximum carrier deviation. It has no effect when the base station uses its internal reference.

Quasi Synch Mode	Carrier Frequency	Maximum Carrier Deviation (Relative to the Frequency Reference)
Off	Any	<30 Hz
On	Multiple of 5 kHz or 6.25 kHz	0 Hz (locked)
On	Not a multiple of 5 kHz or 6.25 kHz	<1 Hz

Printing a Base Station Configuration

The Service Kit lets you print configuration data that you have opened from a configuration file or read from a base station.



Note: Printing to an old-style text printer is not supported; the layout requires the use of large and small fonts.

To print a configuration

1. Select File > Print. The Print Selection dialog box appears.

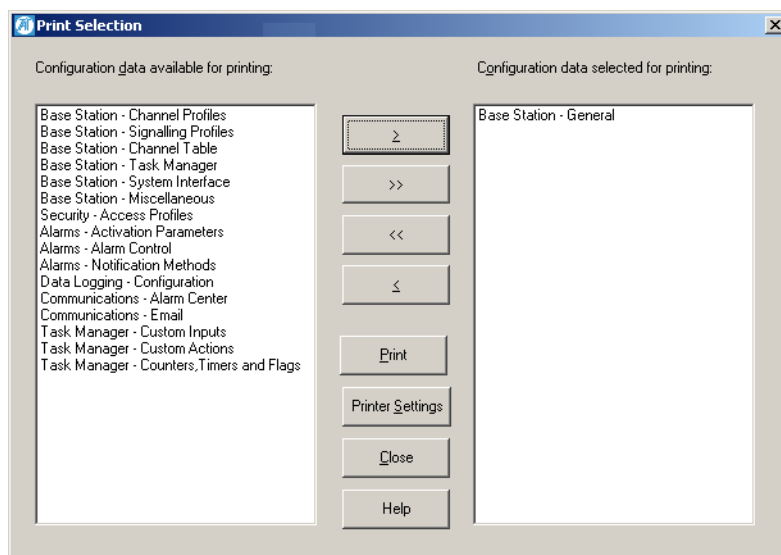

2. Using the arrow buttons, select the configuration items you want printed. An item is selected for printing when it is in the right-hand box.
 - The >> and << buttons move all configuration items.
 - The > and < buttons move the highlighted item. Click an item to highlight it.
3. Click **Printer Settings** and check the printer setup.
4. Click **Print** to send the configuration information to the printer.

Part F **Configuring Channels**

The Service Kit lets you configure the TB8100 base station's [channels](#) and their underlying profiles.

Click **Configure**, and then select an appropriate item from the navigation pane.

Topics

- [Getting Started with Channels](#)
- [Customizing the Default Channel Profile](#)
- [Customizing the Default Signalling Profile](#)

- [Using Advanced Profile Features](#)
- [Working with Channel Profiles](#)
- [Working with Signalling Profiles](#)

- [Working With the Channel Table](#)
- [Selecting a Channel](#)
- [Printing Channel Data](#)

Getting Started with Channels

To set up channels, you first edit the default channel and signalling profiles. This defines the configuration items that are the same for all channels. Then in the [channel table](#) you create the channels you need, for example, by editing the one channel in the table and block copying it to give a set of channels all with the same channel spacing. You then edit the channels as needed, for example, to vary the subaudible signalling for different channels. Finally, you select one channel to be the default.

The following instructions describe the main steps you need to follow. If the base station has the Advanced Profiles and Task Manager license, more options are available. See [“Using Advanced Profile Features” on page 93](#).

To set up channels

1. Open a suitable configuration file or read the configuration of the base station you are logged on to. For more information, see [“Working With Base Station Configurations” on page 42](#).
2. Select Configure > Base Station > General. In the **Default profiles** area, click **Channel Profile**.
3. Edit the settings in the Edit Channel Profile form to reflect the requirements of the channels in the system. For more information, see [“Customizing the Default Channel Profile” on page 90](#). Click **OK** to confirm your changes and return you to the General form.
4. In the **Default profiles** area, click **Signal Profile**.
5. Edit the settings in the Edit Signalling Profile form to reflect the requirements of the channels in the system. For more information, see [“Customizing the Default Signalling Profile” on page 92](#). Click **OK** to confirm your changes and return you to the General form.
6. Select Configure > Base Station > Channel Table to open the Channel Table form.
7. Pick a channel from the table (there may only be one), and give it the first transmit and receive frequencies in the band plan. Make any other configuration changes needed. For details, see [“Editing a Channel \(Default Profiles\)” on page 125](#).
8. Click **Block copy** and specify the number of channels that you need.
If the interval between channels is not regular, or if block copy is not appropriate for any other reason, use **Insert Copy** instead. Copy an existing channel as needed and edit the copies to get the results you want.
9. When the channels are set up to your satisfaction, return to the **General** form (Configure > Base Station > General) and select a channel as the default. All the channels you created will appear in the drop-down list.
10. Click **OK** to commit your changes and close the form.
11. Save the changes to a configuration file.
12. Program the changes into the base station.

Customizing the Default Channel Profile

The Edit Channel Profile dialog box lets you customize the default [channel profile](#) to suit your system. Some items display ‘See channel table.’ You configure them in the [channel table](#) so that you can give different channels different values.

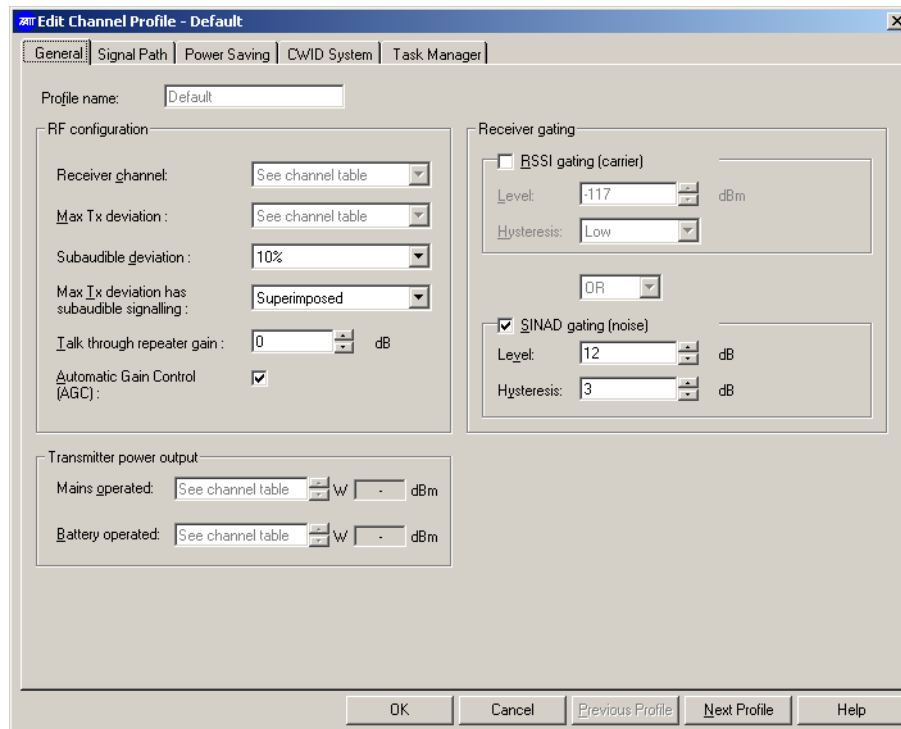

To customize the default channel profile

1. Select Configure > Base Station > General.
2. In the Default profiles area, click **Channel Profile**. The Edit Channel Profile form appears.



Note: If the base station is part of a TaitNet MPT 1327 trunked system, see TN-745 for instructions on how to configure channels and profiles.

3. In the **General** tab, define the following:
 - a. The subaudible deviation if the base station will transmit with CTCSS or DCS.
 - b. The talk-through repeater gain if the base station will be used as a repeater.
 - c. The criteria for receiver gating (see “[Configuring Receiver Gating](#)” on page 96).
4. In the **Signal Path** tab, do the following:
 - a. Use the check boxes to enable the audio paths you require. Enabled paths are displayed as dark lines.
 - b. Select levels for any line inputs and outputs.



Note: The base station can only provide line in and line out audio if the system interface card fitted in the reciter has these audio interfaces.

5. In the [Power Saving](#) tab, configure Normal power saving mode. If the base station has a Power Saving Modes license, you can also configure Sleep and Deep Sleep modes. (See “[Configuring Power Saving](#)” on page 96).
6. If your system needs to broadcast its ID using Morse code, select the [CWID System](#) tab and configure the profile appropriately.
7. In the [Task Manager](#) tab, use Task Manager to define any inputs and actions to customize the way channels with the default profile will respond in different situations.
8. Click **OK** to confirm your changes and close the dialog box.

Customizing the Default Signalling Profile

The Edit Signalling Profile dialog box lets you modify the default signalling profile to suit your system. Some items display ‘See channel table.’ You configure them in the [channel table](#) so that you can give different channels different values.

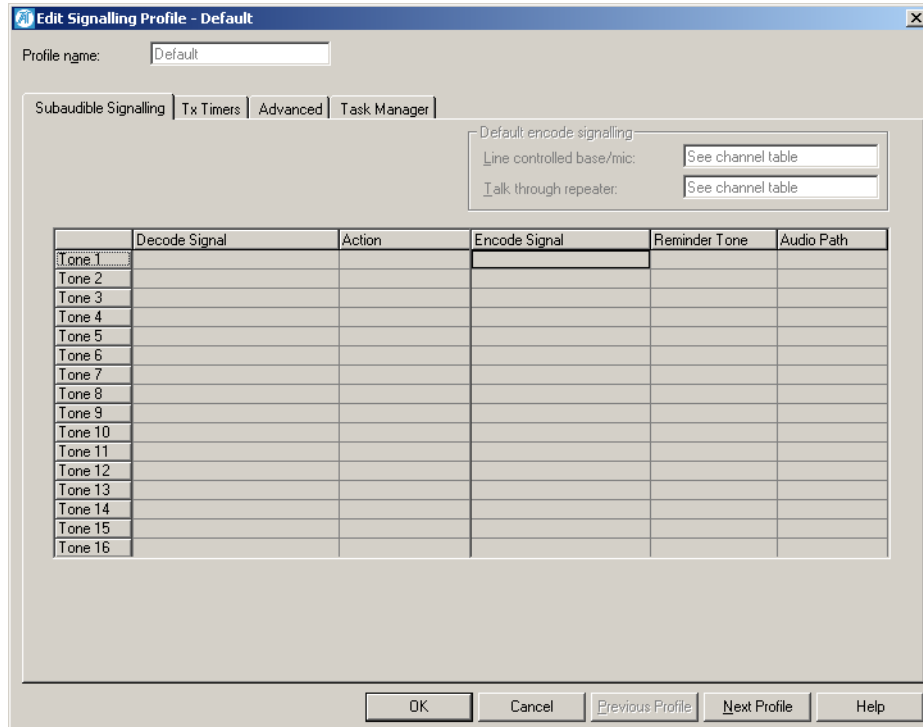

To customize the default signalling profile

1. Select Configure > Base Station > General.
2. In the Default profiles area, click **Signal Profile**. The Edit Signalling Profile form appears.
Nothing in the Subaudible Signalling tab can be configured. Subaudible signalling is defined for each channel in the channel table. The tone table is only available for custom profiles.
3. In the Tx Timers tab, configure the way the audio, signalling, and carrier end at the end of a transmission. You can also enable transmit lockout and anti-[kerchunking](#).
4. In the Advanced tab, check that the settings for [CTCSS](#) gating are suitable.
5. Click **OK** to confirm your changes and return to the General form.

Using Advanced Profile Features

There are two different ways to configure channels. The basic way uses default profiles and the advanced way uses custom profiles. The advanced way requires an Advanced Profiles and Task Manager license.

The basic way defines most settings in the profiles. The rest are defined in the channel table. You select values for each channel.

The advanced way defines nearly all the settings in custom profiles. The channel table only defines the transmit and receive frequencies for each channel. The channel table still displays the same items, but their settings are determined by the profiles assigned to the channels. The advanced way is more flexible and powerful. In the following situations, you **must** use custom profiles:

- The base station needs to respond to more than one subtone. In other words, one channel must be able to decode/encode several different subtones.
- Different parts of the audio path need to use different filters.
- Channel or signalling profile settings need to be different for different channels. In other words, the settings that you specify for the default profiles cannot be used for all channels.
- The receive and the transmit frequencies need to have a different channel spacing.
- You want to use Task Manager to change a profile setting. This is done by getting Task Manager to switch the base station to a channel with a different custom profile.

Many users combine both ways to configure channels. They use default profiles for most channels but create a set of their own profiles for channels with advanced configuration requirements.

Working with Channel Profiles

The Channel Profiles form (Configure > Base Station > Channel Profiles) lets you work with [channel profiles](#). You can view the profile list, add a new profile, or edit an existing one.

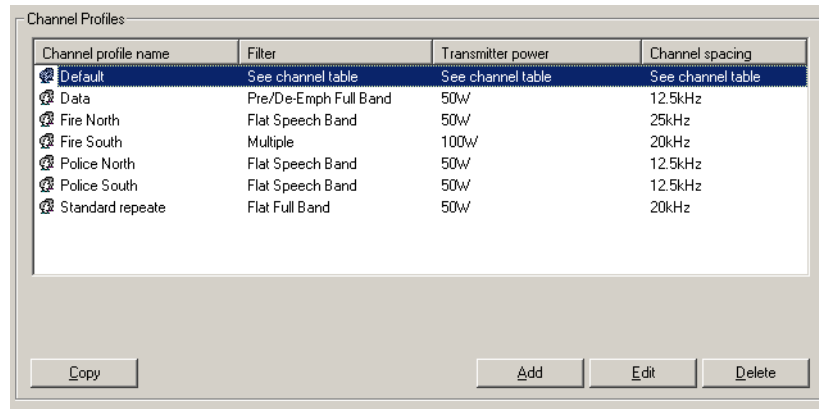

Channel profile name	Filter	Transmitter power	Channel spacing
Default	See channel table	See channel table	See channel table
Data	Pre/De-Emph Full Band	50w	12.5kHz
Fire North	Flat Speech Band	50w	25kHz
Fire South	Multiple	100w	20kHz
Police North	Flat Speech Band	50w	12.5kHz
Police South	Flat Speech Band	50w	12.5kHz
Standard repeate	Flat Full Band	50w	20kHz

The form displays a row of information for each profile. ‘See channel table’ means that the channel table, not the default profile, defines the setting.

The **Channel profile name** column indicates the name of the profile. ‘Default’ is a built-in profile; it can be edited but not deleted.

The **Filter** column indicates the audio filter that the profile specifies. ‘Multiple’ means that different audio paths use different filters. The Default profile does not specify an audio filter; this is done in the channel table.

The **Transmitter power** column indicates the defined transmitter power output. If a custom profile defines different values for mains and battery power, the value for mains power is displayed.

The **Channel spacing** column indicates the nominal or minimum channel spacing of channels that are assigned the profile. If a custom profile defines different values for the transmit and receive frequencies, the value for the receive frequency is displayed.

For more detail about these columns, and about other profile details, see [“Editing a Channel Profile” on page 97](#).

Buttons along the bottom of the form let you add a new profile or copy, edit, or delete the selected profile.

Adding a Channel Profile

The Add Channel Profile dialog box lets you define the settings for a new channel profile and add it to the list of available profiles. You can only do this if the base station has the Advanced Channel and Signalling Profiles feature set.

The following instructions do not deal with all configuration items. For more detailed information about these dialog boxes, see [“Editing a Channel Profile” on page 97](#) (the Add Channel Profile and Edit Channel Profile dialog boxes are almost the same).



Important: If the base station doesn’t have an Advanced Profiles license, don’t add profiles. The channel table cannot use them.



Tip: Set up a test profile and assign it to a channel. Use this channel when testing your system before commissioning.

To add a channel profile

1. Select **Configure > Base Station > Channel Profiles**. The Channel Profile form appears.
2. Click **Add**. The Add Channel Profile window appears.
3. In the **General** tab, define the following:
 - a. A suitable name for the profile.
 - b. The channel spacing for the receiver and the transmitter (they do not need to have the same setting).
 - c. The subaudible deviation if the base station will transmit with CTCSS or DCS.
 - d. The talk through repeater gain if the base station will be used as a repeater.
 - e. The transmitter's RF power output, for mains and for battery operation. You may, for example, want to specify the full output for mains operation, but a lower value when the transmitter is operating from battery power.
 - f. The criteria for receiver gating (see [“Configuring Receiver Gating” on page 96](#)).
4. In the **Signal Path** tab, do the following:
 - a. Use the check boxes to enable the audio paths you require. Enabled paths are displayed as dark lines.
 - b. Using the **Filter** drop-down lists, select for each audio path the filter you want. Thumbnail sketches display graphs of the selected filter's audio characteristics.
 - c. Select levels for any line inputs and outputs.



Note: The base station can only provide line in and line out circuits if the system interface card fitted in the reciter has pins for them.

5. In the **Power Saving** tab, configure power saving. If the base station has a Power Saving Modes license, you can configure all three modes (see [“Configuring Power Saving” on page 96](#)).
6. If your system needs to broadcast its ID using Morse code, select the **CWID System** tab and configure the profile appropriately.
7. In the **Task Manager** tab, use Task Manager to define any inputs and actions to customize the way channels with this profile will respond in different situations.
8. Click **OK** to confirm your changes and close the dialog box. The profile you defined appears in the Channel Profiles form.

Configuring Receiver Gating

The Rx Gating area of the General tab lets you configure the way the receiver [gates](#) the audio signal.

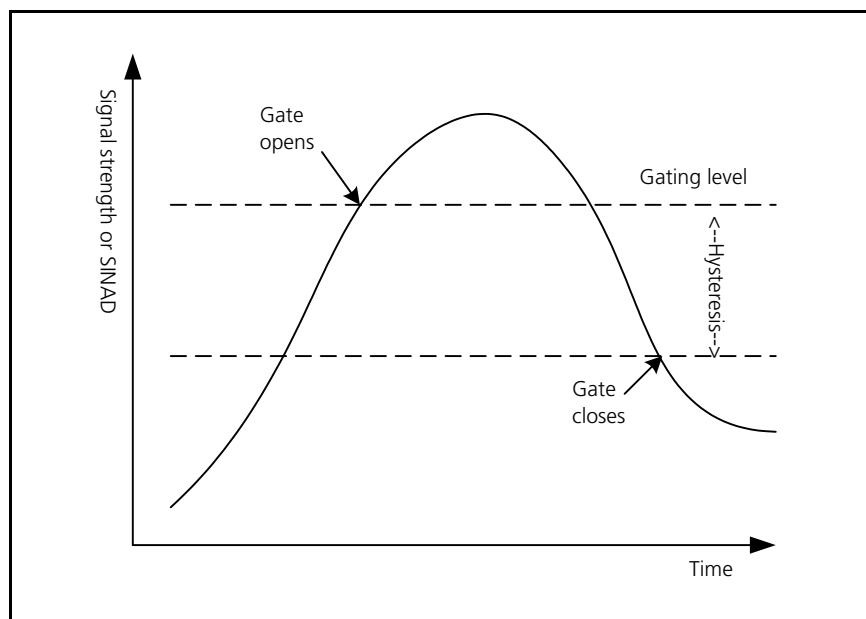

Figure 2: Receiver Gating

To configure receiver gating

1. Open the Add or Edit Channel Profile dialog box for the profile whose receiver gating you want to configure.
2. Select whether the receiver gate will open based on [RSSI](#), [SINAD](#), or both.
3. If you selected both RSSI and SINAD, you need to specify whether both conditions need to be met, or only one. In the receiver gating logic box, select AND or OR. AND means that both RSSI and SINAD must reach their level before the receiver gate opens. OR means that the receiver gate opens if either the RSSI or the SINAD level is reached.
4. In the RSSI and/or SINAD areas, enter a gating level. When the level you set is reached, the receiver gate opens. (If you enabled both gating types and selected AND, both RSSI and SINAD levels must reach their level.)
5. Set the [hysteresis](#). This defines the amount that the RSSI or SINAD must fall below the gating level before the receiver gate closes.

Configuring Power Saving

For each channel profile, you can configure three power saving modes: Normal, Sleep, and Deep Sleep. The configuration will be applied to channels with the profile you are working on.



Note: Sleep and Deep Sleep modes are only available if the base station has a Power Saving Modes license and is operating on battery power.

	Normal	<input checked="" type="checkbox"/> Sleep	<input checked="" type="checkbox"/> Deep Sleep
Rx Cycling:	No Cycling	50 ms	1 second
Tx Keyup time:	1 ms	medium	slow
Start after:		10 minutes idle	1 hour idle

To configure power saving

1. Open the Add or Edit Channel Profile dialog box for the profile whose power saving you want to configure.
2. Select the Power Saving tab.
3. For each power saving mode, follow these steps:
 - a. Select the check box to enable the mode (Sleep and Deep Sleep only).
 - b. In the **Rx cycling** box, select a time from the drop-down list. This specifies how long the receiver is turned off before being turned on again. If you select 'off', there is no receiver power saving in this mode.
 - c. In the **Tx keyup time** box, select a time from the drop-down list. This specifies the amount of time that the transmitter will need to key up. The longer the time, the more circuitry can be switched off. (In Sleep and Deep Sleep modes, the Tx keyup time is fixed.)
 - d. In the **Start after** box, specify a length of time. When the base station has been idle for this length of time, it switches from Normal to Sleep mode, or from Sleep to Deep Sleep mode. 'Idle' means not operating as a talk through repeater or line-connected base station. A base station still counts as idle, even if it makes scheduled CWID transmissions or transmissions using the front panel microphone.



4. If desired, use the Task Manager action Disable Power Saving to disable power saving when it is not needed. For example:

IF **Battery voltage low** THEN **Enable power saving**
 IF NOT **Battery voltage low** THEN **Disable power saving**

Editing a Channel Profile

The Edit Channel Profile dialog box lets you view the details of the selected channel profile and modify them.

Next Profile and **Previous Profile** let you move from one profile to another without leaving the dialog box.



Important: If you have made changes to the current profile, click **OK** to confirm them before moving to another profile.

Some items in the Default channel profile display 'See channel table.' You specify them individually for each channel in the channel table (Configure > Base Station > Channel Table).

General

The General tab in the Add or Edit Channel Profile dialog box names the channel profile and defines its general characteristics.

Profile name Specifies the name of the profile. You can edit the name of custom profiles.

RF Configuration

In the Add or Edit Channel Profile dialog, General tab, the RF configuration area lets you specify the nominal channel spacing for the receiver and the transmitter. No hardware modification is necessary when the RF configuration is changed.



Note: Your country may use Narrow band, Mid band and Wide band to refer to different channel spacings. Make sure that the option you select has the correct value.

Receiver channel Specifies the receiver's nominal channel spacing. The available options are expressed both as a description (for example, Mid Band) and as the kHz value of the nominal channel spacing.

Option	Equivalent Rx IF Bandwidth
12.5 kHz Narrow Band	7.5 kHz
20 kHz Mid Band	12 kHz
25 kHz Wide Band	15 kHz



Note: The **Receiver channel** box does not determine the actual spacing between channels. It determines the receiver IF bandwidth. For example, 20 kHz Mid Band sets the receiver IF bandwidth to 12 kHz. Normally, you would select this option if the channels in your band plan have a 20 kHz channel spacing. However, your band plan may be irregular, or you may want to specify (in the channel table) a greater spacing between channels, for example, 50 kHz.

Max Tx deviation Specifies the highest deviation that the transmit channel is permitted to have. The available options correspond to the following channel spacings:

Option	Channel Spacing
2500 Hz Narrow Band	12.5 kHz
4000 Hz Mid Band	20 kHz
5000 Hz Wide Band	25 kHz

Subaudible deviation Specifies the deviation that [CTCSS](#) or [DCS](#) signalling will cause to the carrier frequency. Options are specified both absolutely in Herz and relatively as a percentage of the selected Max Tx deviation. Gain will be applied to the CTCSS signalling to cause the deviation specified. If you subsequently alter the Max Tx deviation, the Herz value of the subaudible deviation will alter, but not its percentage.

Max Tx deviation has subaudible signalling Specifies whether subaudible signalling adds to the actual maximum transmit deviation or is included in it. It is important to select the correct option to ensure that you comply with the relevant standards.

Option	Description
Superimposed	<p>The subaudible (10–300 Hz band) deviation does not alter the audio (0.3–3.4 kHz band) deviation transmit levels. The audio path signal thus uses all the allocated channel deviation and subaudible signals are summed on top of the audio signal. It is therefore possible to transmit levels that exceed the channel limits.</p> <p>For example, if a wide band channel is configured with a subaudible deviation level of 10% and a line input level of -10 dBm, its transmit deviation (with the subaudible signal filtered out) will be 3.0 kHz, when the line audio input is -10 dBm.</p>
Included	<p>The subaudible deviation reduces the level of the audio deviation out of the limiter by the amount of subaudible deviation selected. This ensures that the radio will never transmit levels that exceed the maximum transmit deviation when using subaudible signalling.</p> <p>For example, if a wide band channel is configured with a subaudible deviation level of 10% and a line input level of -10 dBm, its transmit deviation (with the subaudible signal filtered out) will be 2.5 kHz, when the line audio input is -10 dBm. The maximum in-limiting deviation will be 4.5 kHz, within the 5 kHz channel limit.</p>

Talk through repeater gain Specifies the gain in dB that will be applied to received audio that is fed into the transmitter. See [“Repeater Options” on page 106](#).

Automatic gain control (AGC)

Specifies whether automatic gain control is applied to received audio. AGC provides enhanced high signal handling capabilities and receiver intermodulation protection. When signal levels are high, however, the minimum sensitivity may be degraded.

AGC is normally enabled, but Tait recommends disabling it when:

- The anticipated receive signal strength is < -107 dBm (1 microvolt) and strong interfering signals (> -30 dBm (7000 microvolts)) are anticipated at the receiver input.
- TIA/EIA or AS-4295 RF performance testing is being carried out.

Transmitter Power Output

In the Add or Edit Channel Profile dialog, General tab, the **Transmitter power output** area specifies the output power of the transmitter.

The output power is specified separately for mains-powered and for battery-powered transmissions. The boxes alongside display the equivalent power in dBm.

If you specify 100 W and the PA is rated at 50 W, it will run at 50 W. There is therefore no need to alter this value if you temporarily substitute an amplifier with lower power, for example, if there is a fault and you don't have a fully powered module on hand.

Receiver Gating

In the Add or Edit Channel Profile dialog, General tab, the Receiver Gating area configures receiver [gating](#) (also known as receiver squelch).

Receiver gating

RSSI gating (carrier)

Level: -110 dBm

Hysteresis: Low

OR

SINAD gating (noise)

Level: 12 dB

Hysteresis: 3 dB

You can have gating based on:

- [RSSI](#)
- [SINAD](#)
- RSSI and SINAD
- RSSI or SINAD

RSSI gating operates more quickly and is suitable for repeater links. SINAD gating takes longer but is more accurate and is suitable for the repeater itself or for a line-connected base station. For information about gating in a base station with Power Save, see

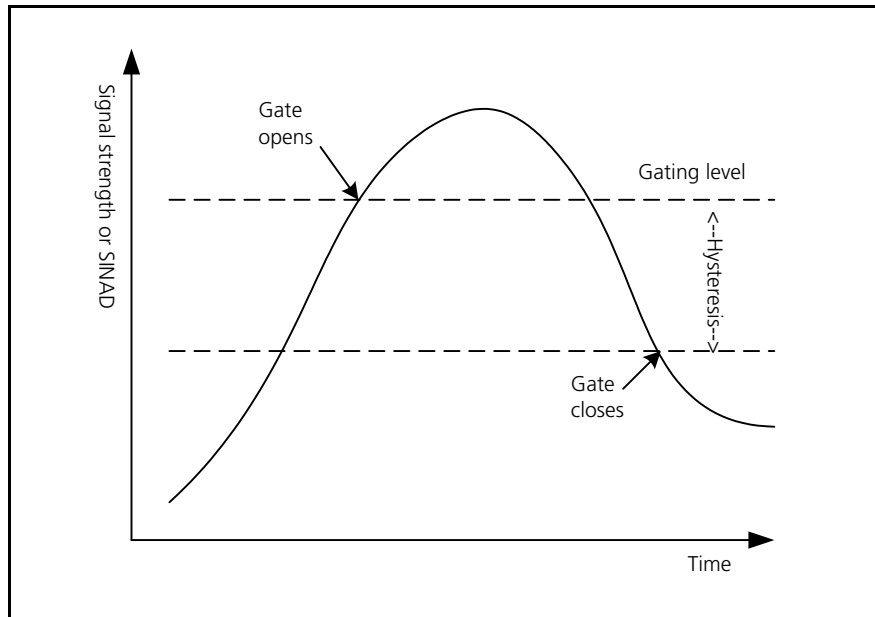

RSSI Gating
(carrier)

Enables gating based on the base station's measurement of the received signal strength. This is also known as Carrier gating. This method is not recommended for low signal levels. If the level is set low (for example -118 dBm) and the hysteresis is set to High, the gate may stay open permanently.

SINAD Gating
(noise)

Enables gating based on the ratio of signal to noise and distortion. This is also known as noise gating.

Gating logic

When both RSSI and SINAD gating options are enabled, an unlabeled drop-down list box lets you specify the gating logic.

Option	Description
AND	The receiver gate opens when both RSSI and SINAD values reach the required level.
OR	The receiver gate opens when just one of the RSSI or SINAD values reaches the required level. You can set the RSSI level high (for example -100 dBm) for quick gating when the signal level is high and also have SINAD gating when the



Tip: Select OR and set the RSSI level high (for example -100 dBm). This gives you quick gating when the signal level is high. When the signal level is low, gating occurs based on SINAD. This is slower but more accurate.

Level

The two Level boxes define the level (of RSSI or SINAD) required to enable receiver gating and pass the received audio.

Hysteresis

The two [Hysteresis](#) boxes specify how far the RSSI or SINAD must fall below the level set in the corresponding Level box to disable receiver gating and mute the received audio.

The Hysteresis box for RSSI gating provides the options Low, Medium, and High. Typically, these options correspond to hysteresis values of 1–2, 2–5, and 5–10 dB respectively. The actual hysteresis varies with the RSSI gating level (see below).

Set the hysteresis level you want, test TB8100 operation, and adjust the setting as appropriate.

Table 1: Typical hysteresis values for the different hysteresis options

Gating Level	Low	Medium	High
-119 dBm	0.8	3.5	5
-118 dBm	1.1	3.4	5.9
-117 dBm	1.3	3.8	5.4
-116 dBm	1.9	3.9	6
-115 dBm	2.2	4.7	6.4
-114 dBm	2.4	4.7	6.4
-110 dBm	2.9	5.6	7.4
-105 dBm	3.4	6.1	8.1
-100 dBm	3.8	6.8	8.7
-95 dBm	4.1	2.8	8.6
-90 dBm	4.7	7	9.2



Note: SINAD dB hysteresis is a recovered audio level measurement. It does not correlate to RF dBm levels.

Signal Path

In the Add or Edit Channel Profile dialog, the Signal Path tab lets you configure the path that incoming and outgoing signals take. In effect, you can design your own virtual backplane for the base station.

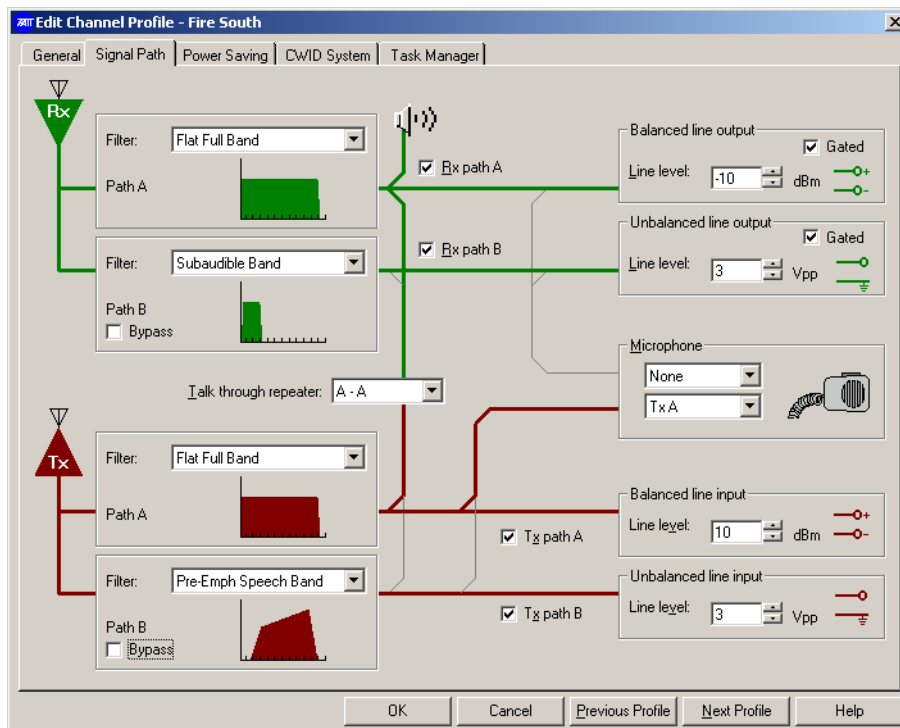

The left-hand side of the tab defines RF filter characteristics. Each panel has a drop-down list you can choose from, and a thumbnail graphic showing you the response characteristics of the filter you chose.

The middle of the tab displays possible audio paths as light gray lines. Check boxes and a drop-down list let you select path options. When you select an item, the path it enables appears as a thick green (transmit path) or red (receive path) line.

Both the receiver and the transmitter have two paths. Path A connects to a [balanced line](#) and Path B to an [unbalanced line](#). You can select different filters for each path.



Note: You can use Task Manager to disconnect or re-connect parts of the signal path in particular circumstances. See [“Channel Profile Actions” on page 193](#). Also, Task Manager actions can connect the balanced line input to the balanced line output, or the unbalanced line input to the unbalanced line output. See [“Loopback actions” on page 190](#).



Important: The transmitter can be keyed from several different sources. If the instruction to key up is received from more than one keying source, the source with the highest priority level takes precedence. Only the audio that belongs to the keying source will be used to modulate the transmission. The keying sources and their priority levels are:

Priority Level	Keying Source	Audio Used
1	Carrier button on control panel	None
2	PTT on microphone connected to base station	Microphone
3	External Tx Key line	Balanced and/or unbalanced line input
4	Valid Receive signal (no separate Tx Key line required)	Output from receiver



Tip: To transmit audio that is summed from line input and from the receiver, connect one line output to the corresponding line input and connect external audio to the other line input. In other words, loop the received audio back externally because the internal signal path from receiver to transmitter will not be used when the Tx Key line is active.

Receive Path

In the Add or Edit Channel Profile dialog box, the top half of the Signal Path tab lets you configure receive paths. A receive path connects the receiver to the speaker output and to a line output.

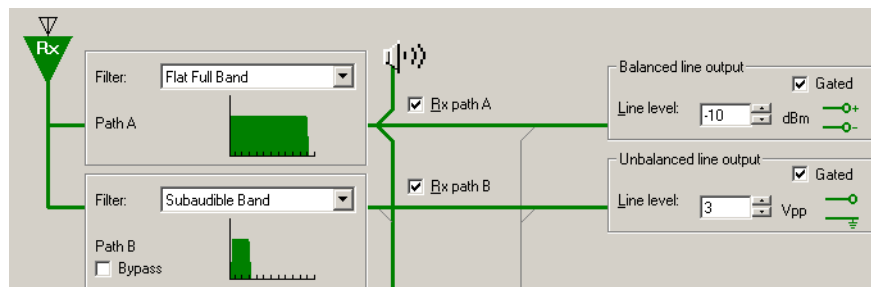

Note: The path to the speaker is always enabled. However, the speaker buttons on the control panel let you turn the speaker off and mute or unmute its audio.

Filter The Filter drop-down lists let you select an audio filter for each enabled receive path.

Option	Description
Flat full band	Passes audio evenly across the audio spectrum.
Flat speech band	Passes only speech frequencies.
De-emph speech band	Passes audio in the speech range, attenuating higher frequencies. This option can be used if the base station will receive pre-emphasised transmissions.
De-emph full band	Passes all audio, attenuating higher frequencies. This option can be used if the base station will receive pre-emphasised transmissions.
Subaudible band	Passes only the subaudible band, containing any CTCSS tones or DCS codes. This option can be used to separate out the signalling and put it on the line output that is connected to a tone panel.



Note: The Path B filter does not appear if the Bypass check box is selected.

Rx path A Enables the audio path from the receiver to balanced audio output, using the filter selected for Path A.

Rx path B Enables the audio path from the receiver to unbalanced audio output, using the filter selected for Path B.

Bypass Bypasses the receiver filters and limiters. This check box is generally cleared, but must be selected for TaitNet MPT1327 trunked networks, to minimise the time delay through the base station. This is important when the base station is handling FFSK data. See TN-745 for details.



Important: If the limiters are bypassed, you must take steps to make sure that overdeviation does not occur.

Line level The Line level boxes on the receive path set the audio level at the line output pins. When the reciter receives a signal that is modulated to 60% of a maximum transmit deviation that is equivalent to the receiver setting, it outputs audio on the line at the level you set. For channels using the default profile, the receiver setting is determined by the channel spacing (see [“Channel Spacing” on page 124](#)). For channels using custom profiles, it is defined by the Receiver channel box (see [“Receiver channel” on page 98](#)).

Receiver setting	Equivalent Max Tx deviation (Hz)	60% of Max Tx deviation (Hz)
12.5 kHz Narrow Band	2500	1500
20 kHz Mid Band	4000	2400
25 kHz Wide Band	5000	3000

The line level units are dBm for the balanced line output and Vpp (voltage peak-to-peak) for the unbalanced line output.

Gated

Each line output has a Gated check box. Generally, the check box is selected. This outputs audio only when the required conditions (RSSI level, SINAD level, subaudible signalling) are met. When the check box is cleared, receiver gating is not applied to the audio on the line output. This makes continuous listening to the channel possible, for example, when troubleshooting.



Tip: You can configure the base station to output line audio differently in different circumstances. Define two profiles with the different options. Create two channels that are the same except for the assigned channel profiles. Then define Task Manager tasks that switch the base station between the two channels, for example, when it receives a particular subtone.

Repeater Options

In the Add or Edit Channel Profile dialog box, Signal Path tab, the Talk through repeater box specifies the audio path from receiver to transmitter.



Important: If the base station uses the same frequency for transmitting and receiving, it cannot function as a repeater. You must select 'Disabled.'

Option	Description
Disabled	There is no audio path. The base station does not function as a repeater.
A-A	The base station filters received audio using the receive Path A filter and transmits it using the transmit Path A filter.
A-B	The base station filters received audio using the receive Path A filter and transmits it using the transmit Path B filter.
B-A	The base station filters received audio using the receive Path B filter and transmits it using the transmit Path A filter.
B-B	The base station filters received audio using the receive Path B filter and transmits it using the transmit Path B filter.



Note: You can vary the gain that the base station applies to talk through audio. See [“RF Configuration” on page 98](#).

Microphone Panel

In the Add or Edit Channel Profile dialog box, Signal Path tab, the two Mic drop-down lists specify the line output and transmit audio paths for any microphone connected to the control panel.

The upper drop-down list specifies the microphone's line out audio path.

Option	Description
None	The microphone has no line audio path.
Balanced	Connects the microphone to the balanced line output.
Unbalanced	Connects the microphone to the unbalanced line output.
All	Connects the microphone to both the balanced and unbalanced line outputs.

Mic

The lower drop-down list specifies the microphone's transmit audio path.

Option	Description
None	The microphone has no audio path to the transmitter
Tx A	Connects the microphone to the transmitter using the Path A filter
Tx B	Connects the microphone to the transmitter using the Path B filter



Tip: Select Tx A or Tx B so that a technician can use a microphone to transmit using the base station.

Transmit Path

In the Add or Edit Channel Profile dialog box, Signal Path tab, the lower area lets you configure transmit paths. A transmit path connects received audio or a line input to the transmitter.



Filter

The Filter drop-down lists let you select an audio filter for each enabled transmit path. The options are the same as for the receive paths, except that [Pre-emphasis](#) filters replace the de-emphasis ones.

Option	Description
Flat full band	Passes audio evenly across the audio spectrum.
Flat speech band	Passes only speech frequencies.
Pre-emph speech band	Passes speech, amplifying higher frequencies. This option can be used for transmitting to systems with de-emphasis.
Pre-emph full band	Passes all audio, amplifying higher frequencies. This option can be used for transmitting to systems with de-emphasis.
Subaudible band	Passes only the subaudible band, containing any CTCSS tones or DCS codes. This option can be used to separate out the signalling and put it on the line output that is connected to a tone panel.



Note: The Path B filter does not appear if the Bypass check box is selected.

Bypass Bypasses the transmitter filters. This check box is generally cleared, but must be selected for TaitNet MPT1327 trunked networks. Bypassing the filter minimises the time delay through the base station. This is important when the base station is handling FFSK data. See TN-745 for details.

Line level The Line level boxes on the transmit path define the level of the line input that the base station expects. The line level you select affects the gain across the transmit path.

When the base station receives a line input at the level you select, it transmits at 60% of the maximum transmit deviation. For channels using the default profile, the maximum transmit deviation is determined by the channel spacing (see “[Channel Spacing](#)” on page 124). For channels using custom profiles, it is defined by the parameter Max Tx deviation (see “[Max Tx deviation](#)” on page 99).

Channel spacing	Equivalent Tx max deviation (Hz)	60% of Tx max deviation (Hz)
12.5 kHz Narrow Band	2500	1500
20 kHz Mid Band	4000	2400
25 kHz Wide Band	5000	3000

Line levels are expressed as dBm for the balanced line input and Vpp (volts peak-to-peak) for the unbalanced line input.



Power Saving

In the Add or Edit Channel Profile dialog box, the Power Saving tab lets you configure power saving. A graph shows the meaning of **Rx cycling** and **Tx keyup time**. The three areas below the graph define the parameters for Normal, Sleep, and Deep Sleep modes. Sleep and Deep Sleep modes require a Power Saving Modes license and only occur when the base station is running on battery power.

Power saving involves switching off parts of the base station circuitry. For details see the Installation and Operation manual. To determine the parameter settings needed for a given level of power consumption, refer to the Specifications.

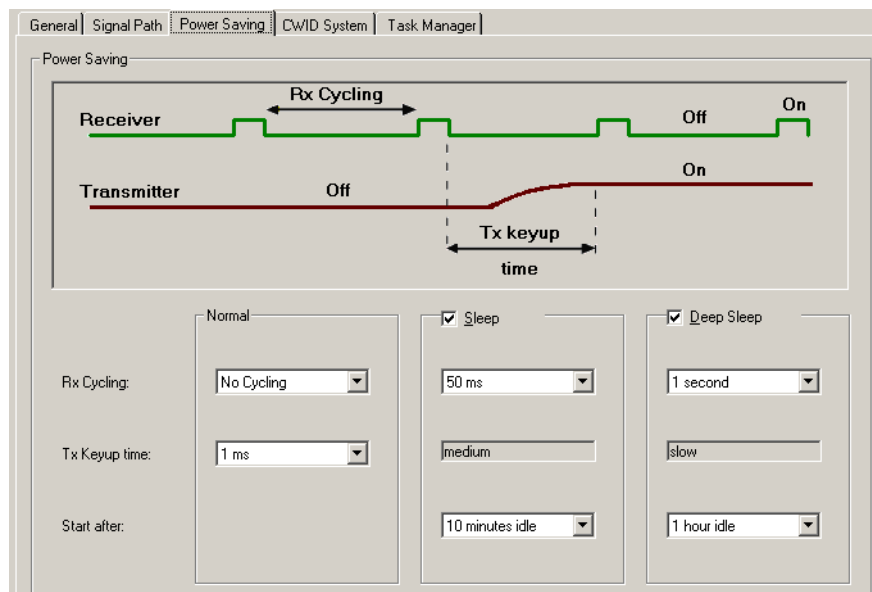

- Normal** Defines how the base station operates normally. Normal mode can involve a degree of power saving.
- Sleep** The Sleep check box enables Sleep mode. The related group box defines how the base station operates in Sleep mode. A base station enters Sleep mode when the receiver has been idle for the length of time specified in the Sleep mode's **Start after** box.
- Deep Sleep** The Deep Sleep check box enables Deep Sleep mode. The related group box defines how the base station operates in Deep Sleep mode. A base station enters Deep Sleep mode when the receiver has been idle for the length of time specified in the Deep Sleep mode's **Start after** box.
- Rx cycling** Rx cycling is the length of time in milliseconds that the receiver is switched off for.
- Power saving is effected by switching off the receiver, switching it back on to check if there is a valid signal, switching it off again, and so on. Rx cycling is the length of time that the receiver is switched off for.
- Even shorter Rx cycling times improve the power consumption significantly and are not noticeable to users. If you select 'No Cycling', the receiver runs continuously.

Tx keyup time The length of time that the transmitter needs for keying up.

Start after The length of time that the base station waits before switching into Sleep or Deep Sleep mode. The timer starts when audio ends.

For example, if the setting is 10 minutes for Sleep mode and 1 hour for Deep Sleep mode, the base station enters Sleep mode 10 minutes after audio ended and Deep Sleep mode 50 minutes after that.

If the base station has to operate as a repeater or line-connected base station, it returns to Normal mode and restarts the timer when transmissions end. If the base station switches from battery to mains power, it also returns to Normal mode. Scheduled CWID transmissions and transmissions using the control panel microphone or Carrier button do not affect the mode or restart the timer.

CWID System

In the Add or Edit Channel Profile dialog box, the CWID System tab lets you configure the way the base station broadcasts its identity using Morse code. In the USA, the FCC requires that base stations broadcast their identity.



Tip: Transmit using [CWID](#) before your radio system is commissioned; if there are any other users of the frequencies you have been assigned, this gives them advance warning.



Tip: Use CWID as an alarm notification method additional to the over the air alarm. Task Manager can disable CWID on startup, and then enable it when particular alarm conditions occur. See “[CWID Actions](#)” on page 195.

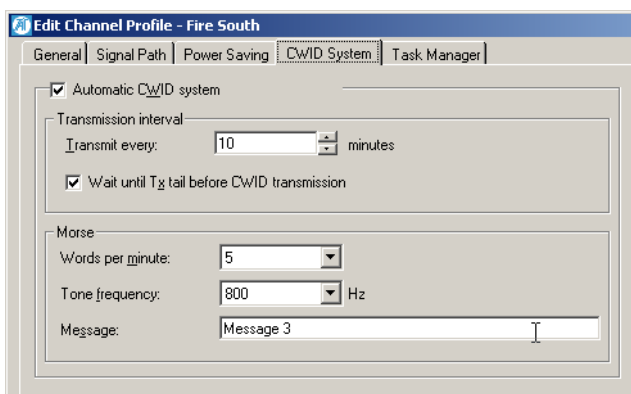

The Automatic CWID system area lets you enable and configure the regular sending of identity broadcasts. The Morse area defines what the base station broadcasts.

Automatic CWID system Enables the automatic sending of a base station identifier. Currently the only option is to use Morse code.

Transmission Interval

In the Add or Edit Channel Profile dialog box, CWID System tab, the Transmission interval area lets you specify when the station ID is transmitted.

Transmit every Specifies the interval in minutes between one identity broadcast and the next.

Wait until Tx tail before CWID transmission

Determines what happens if the base station is transmitting when a CWID burst is due.

If the check box is selected, the base station delays the CWID burst until the transmit tail. Any tail timers start to count down immediately after the CWID burst.

If the check box is cleared, the station ID is transmitted as soon as the transmission interval after the previous transmission has elapsed. This may interrupt speech or signalling. Any other modulating signal is temporarily suppressed to prevent interference with the Morse code.

 **Tip:** Use the Task Manager action **Transmit CWID now** to set up identity broadcasts in ways that the Transmission interval area does not permit.

Morse

In the Add or Edit Channel Profile dialog box, CWID System tab, the Morse area lets you specify a unique ID for the base station. The speed of transmission and the tone used can also be configured, but you should not need to alter the default settings.

Words per minute Specifies the speed of Morse code transmission. The 5-letter word PARIS is used to establish the number of words per minute. This word corresponds to 50 dots.

Tone frequency The frequency of the tone used to transmit the Morse code.

Message Enter into this box up to 30 characters to be transmitted as the station ID. You can enter any character or digit that the international morse code alphabet supports (A-Z, 0-9, and punctuation marks). These characters will be transmitted using the International Morse Code convention. You can also enter spaces. They result in a silence equivalent in duration to seven dots.

Task Manager

In the Add or Edit Channel Profile dialog box, the Task Manager tab opens a Task Manager form and displays the tasks that apply to the selected channel profile. Use it to edit or add Task Manager inputs and actions that apply to the channel profile.

Working with Signalling Profiles

The Signalling Profiles form displays a list of the current [signalling profiles](#).

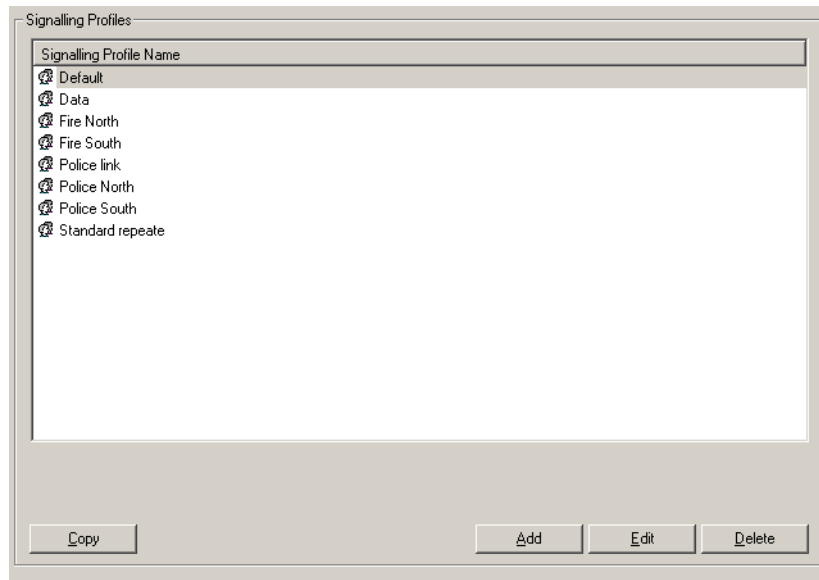

Buttons along the bottom of the form let you add a new profile or copy, edit, or delete the selected profile.

Adding a Signalling Profile

The Add Signalling Profile dialog box lets you define the settings for a signalling profile and add it to the list of available profiles. It is almost the same as the Edit Signalling Profile dialog box. For detailed information, see [“Editing a Signalling Profile”](#) on page 115.



Important: If the base station doesn't have an Advanced Profiles license, it makes no sense to create profiles. The Service Kit lets you create them, but you will not be able to apply them to the channels in the channel table.



Tip: Set up a test profile and assign it to a channel. Use this channel when testing your system before commissioning.

To add a signalling profile

1. Select Configure > Base Station > Signalling Profiles. The Signalling Profiles form appears.
2. Click **Add**. The Add Signalling Profile window appears.

	Decode Signal	Action	Encode Signal	Reminder Tone	Audio Path
Tone 1	None				
Tone 2	None				
Tone 3	None				
Tone 4	None				
Tone 5	None				
Tone 6	None				
Tone 7	None				
Tone 8	None				
Tone 9	None				
Tone 10	None				
Tone 11	None				
Tone 12	None				
Tone 13	None				
Tone 14	None				
Tone 15	None				
Tone 16	None				

3. In the **Profile name** box, enter a suitable name for the profile.
4. In the **Subaudible Signalling** tab, set up the default encoding of transmitted signals.
 - a. In the **Line-controlled base/mic** box, specify the subaudible signalling type and the tone frequency that the base station will use when it transmits audio from its line in.
 - b. In the **Talk through repeater** box, optionally specify the [subtone](#) that the base station will encode by default when it transmits received audio. If you tell the base station to decode any subtone and gate the receiver, this setting is disabled.
5. In the table, specify up to 16 subtones that you want the base station to recognize.
 - a. In the **Decode Signal** column, select a tone or code. CTCSS tones appear prefaced by a 'C' and DCS codes are prefaced by a 'D.' The rest of the row now displays default settings.



Note: When using CTCSS tones, select frequencies that are spread out across the available range. Do not select tones that are close to one another in frequency, as the tone reject bandwidth may not permit separating them. For example, if 67 Hz is received, both the 67 Hz and the 69.4 Hz decoders may operate. The exact select and reject bandwidths vary, see [“CTCSS characteristics” on page 85](#).

- b. If you want the subtone to initiate a [Task Manager action](#), but not to produce any audio, change the **Action** column to display 'Task Manager only'.
 - c. In the **Encode Signal** column, you can tell the base station to transmit a different subtone from the one it received.
6. In the Tx Timers tab, configure the way the audio, signalling, and carrier end at the end of a transmission.
7. In the Advanced tab, configure advanced parameters for CTCSS signalling.
8. In the Task Manager tab, define any inputs and actions to customize the way channels with this profile will respond in different situations.
9. Click **OK** to confirm your changes and close the dialog box. The profile you defined appears in the Signalling Profiles form.

Setting Up a Reminder Tone

If a group of radios using a community repeater are in arrears with their payments, you can configure the base station to send out a reminder tone. If necessary, you can disable audio so that they can transmit but not hear each other.

1. Select Configure > Base Station > Signalling Profiles.
2. Open the editing form of the signalling profile assigned to the base station's current channel.
3. In the row that specifies the decode signal that the group of radios use, click the Reminder Tone cell, and select Enabled from the list that appears.

When you program the base station with these changes, it adds a reminder tone to the transmissions from the group that it re-transmits.



Note: To configure the reminder tone, select the Advanced tab of the Edit Signalling Profile dialog box.

Editing a Signalling Profile

The Edit Signalling Profile dialog box lets you view the details of the selected signalling profile and modify them. Subaudible signalling is defined for the Default signalling profile in the channel table.

	Decode Signal	Action	Encode Signal	Reminder Tone	Audio Path
Tone 1	C 69.4 Hz	Gate Receiver	Same as received	Disabled	Enabled
Tone 2	C 88.5 Hz	Gate Receiver	Same as received	Disabled	Enabled
Tone 3	C 94.8 Hz	Gate Receiver	Same as received	Disabled	Enabled
Tone 4	C 136.5 Hz	Gate Receiver	Same as received	Disabled	Enabled
Tone 5	C 173.8 Hz	Gate Receiver	Same as received	Disabled	Enabled
Tone 6	C 210.7 Hz	Gate Receiver	Same as received	Disabled	Enabled
Tone 7	D 023	Gate Receiver	Same as received	Disabled	Enabled
Tone 8	D 053	Gate Receiver	Same as received	Disabled	Enabled
Tone 9	D 071	Gate Receiver	Same as received	Disabled	Enabled
Tone 10	D 072	Gate Receiver	Same as received	Disabled	Enabled
Tone 11	D 072 i	Gate Receiver	Same as received	Disabled	Enabled
Tone 12	D 261 i	Gate Receiver	Same as received	Disabled	Enabled
Tone 13	D 162 i	Gate Receiver	Same as received	Disabled	Enabled
Tone 14	None				
Tone 15	None				
Tone 16	None				

Profile name Specifies the name of the profile. This name is used in the Channel Table and Signalling Profile forms.

Previous Profile Displays the previous profile. This means you don't need to return to the list of profiles.

Next Profile Displays the next profile in the list.



Important: If you have made changes to the current profile, click **OK** to confirm them before moving to another profile.

Tabs

Subaudible Signalling

In the Add or Edit Signalling Profile dialog box, the Subaudible Signalling tab specifies the **subtones** that the receiver recognizes and that the transmitter applies. The base station supports **CTCSS** frequencies and **DCS** codes.

Most of the tab is taken up by a table. Each row in the table specifies a subtone that the base station will recognize and the action that it will take. Default subtones for the transmitter are specified in the Default encode signalling area.

Subtone table

In the Add or Edit Signalling Profile dialog box, a table defines up to 16 subtones that the receiver will accept and specifies the base station's response. The left-hand side specifies the receive response and the right-hand side the transmit response.

	Decode Signal	Action	Encode Signal	Reminder Tone	Audio Path
Tone 1	C 69.4 Hz	Gate Receiver	Same as received	Disabled	Enabled
Tone 2	C 88.5 Hz	Gate Receiver	Same as received	Disabled	Enabled
Tone 3	C 94.8 Hz	Gate Receiver	Same as received	Disabled	Enabled
Tone 4	C 136.5 Hz	Gate Receiver	Same as received	Disabled	Enabled
Tone 5	C 173.8 Hz	Gate Receiver	Same as received	Disabled	Enabled
Tone 6	C 210.7 Hz	Gate Receiver	Same as received	Disabled	Enabled
Tone 7	D 023	Gate Receiver	Same as received	Disabled	Enabled
Tone 8	D 053	Gate Receiver	Same as received	Disabled	Enabled
Tone 9	D 071	Gate Receiver	Same as received	Disabled	Enabled
Tone 10	D 072	Gate Receiver	Same as received	Disabled	Enabled
Tone 11	D 072 i	Gate Receiver	Same as received	Disabled	Enabled
Tone 12	D 261 i	Gate Receiver	Same as received	Disabled	Enabled
Tone 13	D 162 i	Gate Receiver	Same as received	Disabled	Enabled
Tone 14	None				
Tone 15	None				
Tone 16	None				

The table lets you configure the base station as a community repeater, with each subtone having its own group of users. It also lets you set up the means of remotely initiating [Task Manager actions](#). A radio can send carrier with a particular subtone and the decoding of this subtone initiates a Task Manager action. The left side specifies a subtone. The base station will recognize transmissions containing that subtone. The row defines the base station's response.

Decode Signal

Specifies a subtone and instructs the base station to decode it. To begin adding a subtone to the list that the base station will recognize, click in the cell. A pop-up menu appears. Click an option. When you select a subtone, it becomes unavailable. If the subtone is a DCS code, its inverse also becomes unavailable. This is to prevent you selecting the same subtone twice.



Note: When using CTCSS tones, select frequencies that are spread out across the available range. Do not select tones that are close to one another in frequency, as the tone reject bandwidth may not permit separating them. For example, if 67 Hz is received, both the 67 Hz and the 69.4 Hz decoders may operate. The exact select and reject bandwidths vary, see [“CTCSS characteristics” on page 85](#).

Action

Specifies the action when the base station detects the specified subtone.

Option	Action
Gate receiver	Opens the receiver gate and passes the received audio on. Also sets the system flag 'Tone <i>nn</i> detected' where ' <i>nn</i> ' is the number of the subtone. This flag is a Task Manager input; any tasks with this input will be executed when the base station detects the subtone.
Task Manager only	Sets the system flag 'Tone <i>nn</i> detected' where ' <i>nn</i> ' is the number of the subtone. This flag is a Task Manager input; any tasks with this input will be executed when the base station detects the subtone. In systems that use subaudible signalling, the receiver does not pass the received audio on (the receiver gate only opens when the receiver decodes a tone configured to gate the receiver). In systems that do not use subaudible signalling, the receiver still passes the received audio on (the receiver gate opens irrespective of the subaudible signalling).

Encode Signal Specifies the subtone that the base station encodes when it repeats signals with the subtone specified in the Decode signal column.

Option	Action
Same as received	Encodes the transmission with the same subtone that was in the received signal.
None	Gives the transmission no subaudible signalling.
[any CTCSS tone or DCS code]	Encodes the transmission with the subtone you specify

Reminder Tone When the Reminder Tone column is set to 'Enabled', the base station includes a reminder tone in its transmissions. You configure the reminder tone in the [Advanced](#) tab.

Audio Path By default, the Audio Path column is set to 'Enabled.' When it is set to 'Disabled,' the audio path is disabled, and the base station transmits carrier (and a reminder tone if it is configured to do so), but no audio.

Default encode signalling

In the Add or Edit Signalling Profile dialog box, Subaudible Signalling tab, the Default encode signalling area lets you specify the subtone to be used when transmitting audio from line in and when repeating received signals without subaudible signalling.

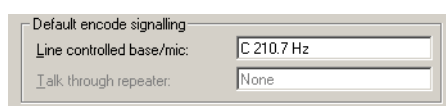

Line controlled base/mic Specifies the subtone to be used when the base station transmits audio from the balanced line input, unbalanced line input, or microphone connected to the control panel.

Talk through repeater Specifies the subtone to be used when the base station repeats any valid received signal. This box is disabled and has no effect if the subtone table below specifies any subtone and gives it the action 'Gate receiver'.

Tx Timers

In the Add or Edit Signalling Profile dialog box, the Tx Timers tab lets you configure tail timers that the transmitter users.

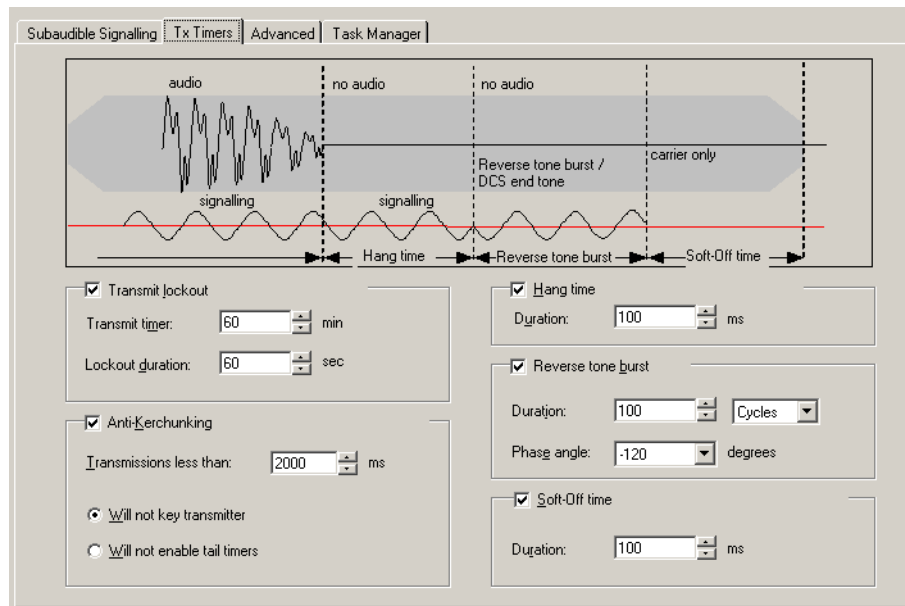

You can also set up a transmit lockout and enable anti-kerchunking.

Three different tail timers give you power and flexibility in tail timing. The total tail time is the sum of all three timers. The graphic at the top of the tab shows the difference between them. Tail timers are used to:

- eliminate squelch tail (the ‘tish’ sound caused when the CTCSS detector doesn’t immediately re-mute the user’s radio when carrier ceases)
- prevent users on different [subtones](#) from taking control of the repeater during a temporary lull in the conversation

Transmit lockout

To prevent radio users from monopolising the base station, you can set a time limit and have the transmitter lock users out for a defined period after this time limit is exceeded. Transmit lockout terminates the current transmission and gives other users the opportunity to use the channel.

In the Add or Edit Signalling Profile dialog box, Tx Timers tab, the **Transmit lockout** check box enables the temporary disabling of the transmitter after a transmission that exceeded the time limit.

The **Transmit timer** box specifies the time limit for transmissions. If a transmission exceeds the time limit, the transmitter is locked out and the conversation cannot continue. The transmitter is unable to transmit for the length of time specified in the **Lockout duration** box.

Anti-kerchunking

Anti-kerchunking discourages radio users from repeatedly pressing PTT briefly to ascertain whether they have service or to reserve the base station for themselves.

In the Add or Edit Signalling Profile dialog box, Tx Timers tab, the **Anti-Kerchunking** check box enables this feature. If a transmission is short, either the transmitter is not keyed up or there will be no tail timers, depending on the option selected.

The **Transmissions less than** box specifies which transmissions are short; those with a duration less than the value in the box. Anti-kerchunking is only applied to short transmissions.

If the **Will not key transmitter** option is selected, short transmissions do not key up the transmitter at all. In effect, this option lengthens the key-up time for all radio users.

If the **Will not enable tail timers** option is selected, short transmissions are transmitted but not given a tail timer. The base station becomes available to other users quickly. The radio user hears nothing on releasing PTT and therefore does not know whether the base station has responded.

Hang time

The hang time is the length of time at the end of each transmission when the base station continues to transmit subaudible signalling after Tx keying has ceased.

In the Add or Edit Signalling Profile dialog box, Tx Timers tab, the **Hang time** check box enables this timer and the **Duration** box specifies the length of the hang time.

Reverse tone burst

The base station can send a [reverse tone burst](#) at the end of each transmission. This applies only to transmissions with a CTCSS tone. The reverse tone burst consists of the same tone, but is out of phase with it. In suitable radios, this quickly mutes the receiver.



Note: Transmissions with a DCS subtone have an equivalent: the DCS end tone. This consists of a 134 Hz tone that lasts 180 ms and is not configurable.

In the Add or Edit Signalling Profile dialog box, Tx Timers tab, the **Reverse tone burst** check box enables reverse tone bursts.

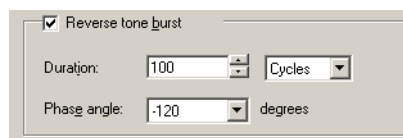

The **Duration** box specifies the length of the tone burst. You can specify this in milliseconds or in cycles. If the burst has too many cycles, it comes back into phase with the original subtone and the radio may detect it again, re-opening the receiver gate. Specifying the duration in cycles for different CTCSS frequencies can help prevent this.

The **Phase angle** box specifies the amount that the burst is out of phase with the original CTCSS subtone. If you select +120 or -120 instead of 180, more cycles are required before the burst comes back in phase with the original subtone.

Soft-off time

The base station can also send only carrier (carrier without modulation of any kind) at the very end of each transmission.

In the Edit Signalling Profile dialog box, Tx Timers tab, the **Soft-off time** check box enables the feature and the **Duration** box specifies the length of time that only carrier is transmitted.

Advanced

In the Add or Edit Signalling Profile dialog box, the Advanced tab lets you define the way the receiver gate responds to signals with **CTCSS** and configure reminder tones if the base station is being used as a community repeater.

CTCSS gating

In the Add or Edit Signalling Profile dialog box, Advanced tab, the CTCSS gating area configures the opening and closing of the receiver gate in response to CTCSS tones.

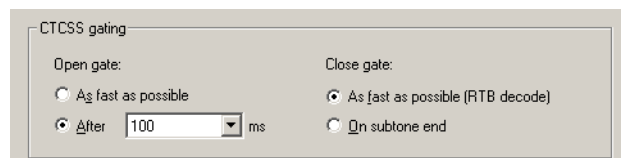

Open gate

You can configure the receiver to open its gate as fast as possible, or after a defined time.

Option	Description
As fast as possible	The base station declares that the receiver input is valid as soon as it detects a valid CTCSS tone. This happens more quickly at higher tone frequencies. The actual speed depends on the CTCSS characteristics (see "CTCSS characteristics" on page 85).
After <i>nnn</i> ms	When RF appears on the RF input, the base station starts a timer and begins decoding the CTCSS tone. After decoding, it waits for <i>nnn</i> milliseconds before declaring that the input is valid and opening the receiver gate.

Close gate

You can tell the receiver whether to recognize **reverse tone bursts**, closing the gate quickly, or whether to close the gate only after ceasing to detect the CTCSS tone.

Option	Description
As fast as possible (RTB decode)	The receiver recognizes the reverse tone burst and closes its gate.
On subtone end	The receiver ignores any reverse tone bursts. When it detects that the subtone on the RF input has ceased, it closes its gate.

Reminder tone

In the Add or Edit Signalling Profile dialog box, Advanced tab, the Reminder tone area lets you configure the reminder tone that can be added to transmissions for a particular talk group.

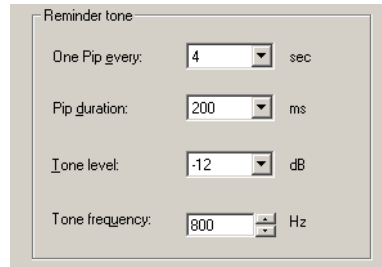

The image shows a dialog box titled "Reminder tone" with four configuration options, each with a dropdown menu and a unit label:

- One Pip every: 4 sec
- Pip duration: 200 ms
- Tone level: -12 dB
- Tone frequency: 800 Hz

One pip every	Specifies the interval between pips.
Pip duration	Specifies the length of time that the pip tone sounds for.
Tone level	Specifies the amplitude of the pip tone relative to the nominal audio level.
Tone frequency	Specifies the frequency of the tone.

Task Manager

In the Add or Edit Signalling Profile dialog box, the Task Manager tab opens a Task Manager form and displays the tasks that apply to the signalling profile named above the tab.

Use it to configure Task Manager inputs and actions that apply to the channel profile.

Working With the Channel Table

The Channel Table form (Configure > Base Station > Channel Table) lets you work with [channels](#). You can view the configured channels, edit them, and add more channels using a variety of different methods.

Channel Table Details

The Channel Table form (Configure > Base Station > Channel Table) displays the channels defined in the [channel table](#) of the configuration file that you opened or the base station database that you read.

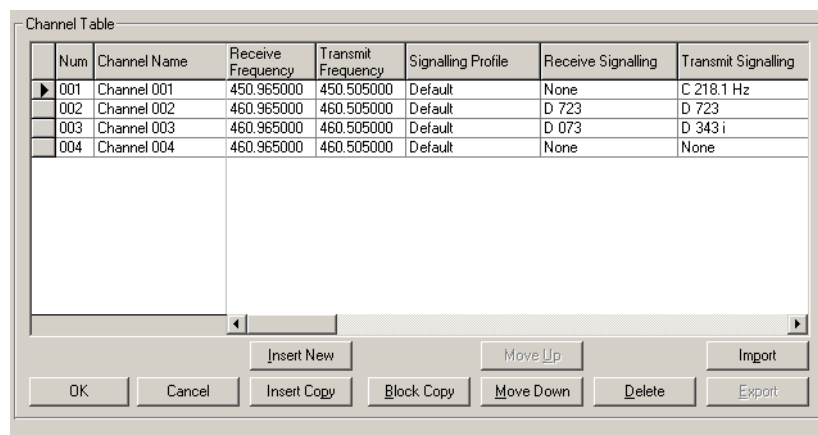

Num	Channel Name	Receive Frequency	Transmit Frequency	Signalling Profile	Receive Signalling	Transmit Signalling
▶ 001	Channel 001	450.965000	450.505000	Default	None	C 218.1 Hz
002	Channel 002	460.965000	460.505000	Default	D 723	D 723
003	Channel 003	460.965000	460.505000	Default	D 073	D 343 i
004	Channel 004	460.965000	460.505000	Default	None	None

The form contains a table that displays a row for each channel. The row indicates which profiles have been assigned to the channel and displays the main configuration items.

If default profiles are assigned, all columns are editable. If a custom profile is assigned, the columns to its right are defined by the profile.

Not all columns are visible; scroll the display to see the rest.

- ▶ An arrow at the left of one row indicates that it is selected; if, for example, you click **Insert Copy**, that row will be copied. Use the mouse or the arrow keys to change your selection. When you make any changes to a row, the arrow changes to a pencil.



Important: The arrow does *not* define the current or default channel. To find out the channel the base station is currently operating on, select Monitor > Monitoring > Base Station. To specify the default channel, select Configure > Base Station > General.

A set of buttons along the bottom lets you work with the channels in the table.

Columns

In the channel table (Configure > Base Station > Channel Table), the first two columns indicate the number and name of each channel. The other columns define the main characteristics of each channel. Not all columns are visible; scroll the display to view them. You can also adjust their width. Some columns you can edit directly; in others a drop-down list appears when you click in the cell. 'Multiple' means that the profile definition defines more than one value for the column's parameter.

	Num	Channel Name	Receive Frequency	Transmit Frequency	Signalling Profile	Receive Signalling	Transmit Signalling
	001	Test UHF Low	400.025000	401.025000	Default	None	None
	002	Test UHF Mid	440.025000	441.025000	Default	None	None
	003	Test UHF High	480.025000	481.025000	Default	None	None

- Num** The number of the channel. This is the number that external channel selection and Task Manager actions use when changing the channel that the base station operates on. If you move a row up or down, its channel number changes. If you edit the channel number, its position in the table changes.
- Channel Name** The name of the channel. When you create a channel, it is given a default name of the form 'Channel *num*' where *num* is the channel number. You can edit this name to reflect the channel's purpose or users.
- Receive Frequency** The radio frequency that the channel receives on.
- Transmit Frequency** The radio frequency that the channel transmits on.
- Signalling Profile** The signalling profile assigned to the channel. This profile defines a group of operating parameters. If the profile is 'Default', the next two columns are editable.
- Receive Signalling** Indicates the subtone that the channel recognizes as a valid signal on its receive frequency. If the signalling profile is 'Default', you can edit this column, otherwise it is defined by the profile. 'Multiple' means that the profile assigned to the channel defines more than one subtone.
- Transmit Signalling** Indicates the subtone that the channel includes in its transmissions. If the signalling profile is 'Default', you can edit this column, otherwise it is defined by the profile. 'Multiple' means that the profile assigned to the channel defines different subtones for different receive signalling.
- Channel Profile** The [channel profile](#) assigned to the channel. This defines a further group of parameters. If the profile is 'Default', the next two columns are editable.
- Filter** Specifies the audio response characteristics of the channel. 'Multiple' means that these are different for different audio paths or that the receive characteristics are different from the transmit characteristics (custom channel profiles only). 'Pre/De-Emph Speech Band' and 'Pre/De-Emph Full Band' mean that pre-emphasis is applied to any enabled transmit path and that the equivalent de-emphasis is applied to any enabled receive path.
- Power** The RF power output that the channel is configured to provide when it is provided with mains power. (The channel profile may specify a different power output for battery power).

Channel Spacing The nominal channel spacing of the channel (the actual channel spacing is determined by the interval between this channel and the adjacent channels in the channel table). Channel spacings correspond to the following IF bandwidths and transmit deviations.

Channel Spacing (kHz)	Name	Rx IF Bandwidth (kHz)	Tx Max Deviation (Hz)
12.5	Narrow Band	7.5	2500
20	Mid Band	12	4000
25	Wide Band	15	5000

If the channel is assigned a custom profile, the receiver can have one channel spacing while the transmitter has another. In this case, the channel table displays the receiver channel spacing.

Buttons

A row of buttons along the bottom of the channel table (Configure > Base Station > Channel Table) lets you work with channels. You can add or remove channels, create a whole new block of channels, or rearrange them into a better order.

Insert New Inserts an additional channel at the end of the channel table. The channel is identical to the last channel in the table except for the channel number.

Insert Copy Inserts a copy of the selected channel at the end of the table.

Block Copy Lets you add a number of channels to the channel table, each with the properties of the selected channel, except that the channels all have a channel spacing that you specify. See “Block Copying Channels” on page 126 for more information.

Move Up Shifts the current row above the previous row, effectively renumbering it with the previous channel number. You can use Move Up and Move Down to give the list of channels a more logical or tidy order, or to group channels in particular ways.



Important: Move Up and Move Down assign a different number to the channel. If you use them, you may need to alter the default channel selection, any external channel selection, and any Task Manager actions that change channel.

Move Down Shifts the current row below the previous row, effectively renumbering it with the next channel number.

Delete Removes the current row from the channel table.

Import Lets you add a set of channels from a file exported from another base station. See “Importing Channels” on page 127.

Export Lets you save a set of this base station’s channels to a file so that you can import them into other base stations. See “Exporting Channels” on page 127.

Editing a Channel (Default Profiles)

When a channel has the default profiles assigned to it, you can edit most of the cells in its table row.

To edit a channel

1. In the channel table (Configure > Base Station > Channel Table), click in the row that defines the channel. An arrow appears at the left of the row indicating that it is selected.
2. If desired, click in the **Channel Name** cell and edit the channel's name.
3. If necessary, alter the receive frequency and the transmit frequency.



Note: The Service Kit does not check whether the base station can operate on these frequencies.



Note: You cannot assign a frequency in the range 406.0-406.100 MHz. These frequencies are reserved internationally for distress beacons.

4. If the system requires subaudible signalling, configure it as follows:
 - a. In the **Receive Signalling** column, select the subtone that the base station will receive.
 - b. In the **Transmit Signalling** column, select the subtone that the base station will transmit.
5. In the **Filter** column, select the appropriate audio filter. See [“Filter” on page 105](#) for more information about the available options.
6. In the **Output Power** column, specify the transmitter's RF output power.
7. In the **Channel Spacing** column, specify a nominal channel spacing for the transmit and receive channels. For more information, see [“Channel Spacing” on page 124](#).
8. Click **OK** to confirm your changes and close the form.



Note: If you are editing a large number of channels, periodically select File > Save to save the changes to a file on disk.

Editing a Channel (Custom Profiles)

If you assign custom profiles to a channel, most of the columns become read-only. The channel is largely defined by the settings in the assigned profiles.

To edit a channel

1. In the channel table (Configure > Base Station > Channel Table), click in the row that defines the channel. The arrow appears at the left of the row indicating that it is selected.
2. If desired, click in the **Channel Name** cell and edit the channel's name.
3. If necessary, alter the receive frequency and the transmit frequency.



Important: Do not assign a prohibited frequency to the transmitter. For example, 406.0-406.100 MHz is reserved internationally for distress beacons.



Note: The Service Kit does not check whether the base station can operate on these frequencies.

4. Click in the **Signalling Profile** cell. An arrow appears at the right of the cell. Click it and select a profile from the drop-down list. This list contains all the profiles defined in Configure > Base Station > Signalling Profiles.
5. If you selected the Default profile, you can edit the **Receive Signalling** and the **Transmit Signalling** cells. If you selected a custom profile, these cells are read-only; they display what has been defined in the profile. To change them, you must select a different profile or alter the current profile's settings.
6. In a similar way, select a channel profile.
7. Click **OK** to confirm your changes and close the form.



Note: If you are editing a large number of channels, periodically click **OK**, and then **Save**.

Adding and Copying Channels

The Channel Table form (Configure > Base Station > Channel Table) has a row of buttons along the bottom that give you a variety of methods for adding to the number of channels.

Insert New

The Insert New button inserts a row below the current row. The row is contains default values and is assigned the Default profiles.

Insert Copy

The Insert Copy button copies the current row and inserts it below that row. The channel number is incremented.

Block Copying Channels

In the channel table, **Block Copy** lets you create a block of channels. Each channel in the block has its own frequency pair, but all other configurations are the same. You can subsequently edit any channel as desired.

1. Select Configure > Base Station > Channel Table.
2. Click in the row of the channel that you want to block copy.
3. Click **Block Copy**. The Block Copy dialog box appears.

4. In the **Channel block start** box, enter the channel number of the first channel you want to create.
5. In the **Channel block end** box, enter the channel number of the last channel in the block.
6. In the **Receive frequency increment** box, enter a number of kHz. This determines how much the receive frequency of a channel differs from the previous channel. For example, if you enter 15 kHz and the previous channel's receive frequency is 10 MHz, the next channel's receive frequency will be 10.015 MHz.



Important: Do not assign a prohibited frequency to the transmitter. For example, 406.0–406.100 MHz is reserved internationally for distress beacons.



Note: The Service Kit does not check whether the base station can operate on these frequencies.

7. In the **Transmit frequency increment** box, specify the number of kHz that the transmit frequency will increment for each channel you add.
8. Click **OK** to create the block of channels and close the dialog box. The channels appear in the Channel Table form.

Importing Channels

You can import a file containing channels that have been exported from another base station. Importing overwrites any channels with the same number as the imported channel. Imported channels always have the default signalling and channel profiles.

To import channels

1. In the Channel Table form (Configure > Base Station > Channel Table), click **Import**.
2. Navigate to the folder containing the TB8100 channel file (*.t8h), select it, and click **Open**.

Exporting Channels

You can export channel configurations. This provides an exported channel file that you can import into other base station channel tables. It also generates a text file for your records.

To export channels

1. In the Channel Table form (Configure > Base Station > Channel Table), select the channels you want to export by holding down the Control key and clicking the row selector at the left of the table.
2. Click **Export**.
3. Specify the path and file name for the file you want to create.
4. Click **Save**.

The Service Kit saves the file, giving it the extension .t8h. It also saves an equivalent text file with the same name and with the extension .txt. The text file gives you a readable view of the exported channel. Editing this file has no effect on the exported channels.

Selecting a Channel

After you have set up a number of channels, you need to specify the one that the base station will actually operate on.

1. Select Configure > Base Station > General.
2. In the **Default channel** box, choose a channel from the drop-down list.

This is the channel that the base station will operate on, unless it uses external channel selection or a [Task Manager action](#) changes channel or makes a different channel the default.

Printing Channel Data

You can print channel and other configuration data that you have opened from a configuration file or read from a base station.



Note: Printing to an old-style text printer is not supported, because the layout requires the use of large and small fonts.

To print channel data

1. Select File > Print. The Print Selection dialog box appears.
2. Using the arrow buttons, select the configuration items you want to print. An item is selected for printing when it is in the right-hand box.
 - The >> and << buttons move all configuration items.
 - The > and < buttons move the highlighted item. Click an item to highlight it.
3. Click **Printer Settings** and check the printer setup.
4. Click **Print** to send the configuration information to the printer.

Part G Alarms

The Service Kit can monitor the current status of a base station's alarms. It can also display the alarm log (a list of recent alarms). Many alarms have thresholds that you can alter to suit the application. Unwanted alarms can be disabled.

The base station can notify you in various ways when alarms occur. Use the Service Kit to enable and configure these notification methods.

Topics

- [About Alarms](#)
- [Monitoring Alarms](#)
- [Viewing Recent Alarms](#)
- [Disabling Unwanted Alarms](#)
- [Altering Alarm Thresholds](#)
- [Notifying Alarms](#)
- [Configuring Alarm Center Communications](#)
- [Configuring Email Messaging](#)

Monitoring Alarms

The Current Status form (Monitor > Alarms > Current Status) shows the current status of alarms in the base station. The Service Kit must be connected and logged on to the base station.

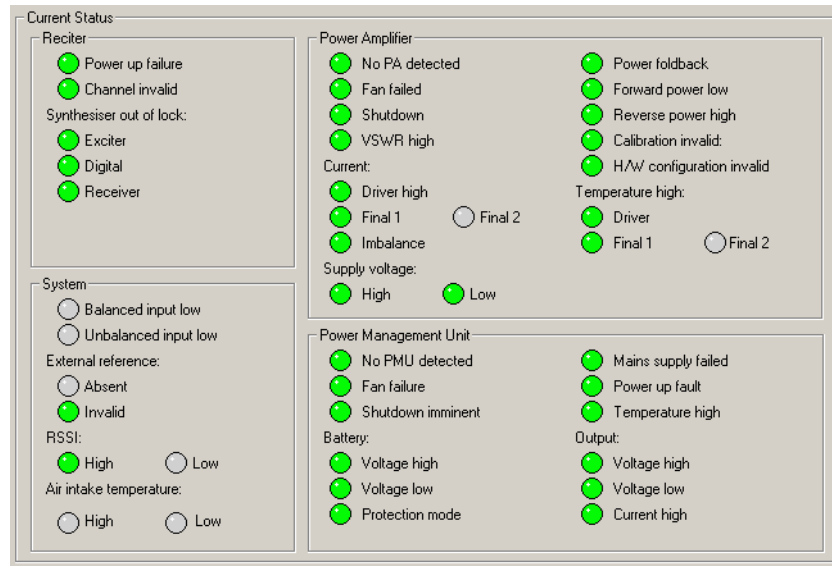

LED-like icons indicate the status:

- Red (flashing) means that the alarm is active.
- Green means that the monitored condition is OK and that there is no alarm.
- Gray means that the alarm has been disabled or that the monitored condition is not available; for example, Final 2 alarms are gray if there is no Final 2 stage.

Alarms are triggered when a monitored condition crosses a defined threshold. Some thresholds are fixed and built into the module firmware. Others are configurable in Configure > Alarms > Thresholds. Some parameters such as high voltage and high reverse power have two thresholds. When the configurable threshold is crossed, the base station generates an alarm. When the built-in threshold is crossed, the base station responds by protecting itself against damage.



Tip: Use Task Manager to configure an automatic response to alarms. In general, each alarm has an equivalent Task Manager input. When the alarm occurs, Task Manager executes any tasks with that alarm as an input.

Reciter

The Reciter area shows the Alarm status of the reciter.

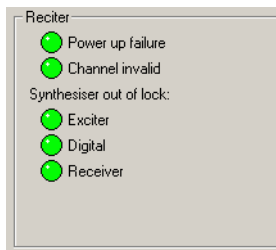

Power up failure

The reciter has failed one or more of its initialisation self-tests and has gone into Download mode. The transmitter and receiver are disabled and any system interface outputs are deactivated.



Note: This alarm will not show if the reciter cannot communicate with the Service Kit.

1. Make sure that there isn't another reciter in the BSS with the same [control bus](#) number.
2. Reset the base station. This may clear the fault.
3. Send the reciter to a Service Center.

Channel invalid

The base station has received an instruction to select an invalid channel number and has stopped transmitting and receiving.

The channel could be invalid for one of the following reasons:

1. The channel number specifies a UHF frequency, but the base station is VHF, or vice versa.
2. The base station cannot lock onto the specified frequency. To verify if this is the cause, do a diagnostic test to see if the base station can lock onto the frequency. See "[Determining Synthesiser Lock Ranges](#)" on page 158.
3. There is a problem with the external selection of the channel.
 - a. Select Monitor > Monitoring > Base Station to determine whether the channel number is determined by hardware.
 - b. Select Diagnose > Reciter > Digital I/O to see what the base station thinks the hardware channel is set to.
 - c. Select Configure > Base Station > System Interface to check that the base station is configured to correctly interpret the channel selection. Are the settings for Binary or [BCD format](#) and for Invert correct?
 - d. Select Configure > Base Station > Channel Table to see whether a configuration for the externally selected channel exists.
4. A [Task Manager action](#) asked the base station to go to a channel number that does not exist in the channel table.
 - a. Check to see if a recent Task Manager action has changed the channel number (Monitor > Task Manager > Recent Actions).
 - b. Look in the channel profile folders in the Task Manager task list to see if there are any 'go to channel' actions. Note the number of the channel that Task Manager instructed the base station to go to.

- c. Select Configure > Base Station > Channel Table to see whether a configuration for that channel exists.

Synthesiser out of lock

The reciter has three different synthesiser alarms.

Synthesiser out of lock: Exciter

The exciter synthesiser is unable to lock on to the frequency it is configured to operate at. In response, the base station disabled the transmitter.

1. Check that this frequency is within the exciter’s RF frequency range.
2. Do a diagnostic test to determine the reciter’s [switching range](#), and then check that the frequency is within the exciter’s switching range.
3. If the frequency is outside the switching range, use the Calibration Kit to alter the switching range. Otherwise send the reciter for repair.

Synthesiser out of lock: Digital

One or more of the DSP and sampling clocks is out of lock. In response, the base station disabled the receiver and the transmitter.

1. The base station is configured for an external reference of a particular frequency, but the actual frequency of the external reference is different.
2. The master synthesiser is unable to lock onto the frequency. The base station will run, but the accuracy of its receive and send frequencies cannot be guaranteed. Send the reciter for repair.

Synthesiser out of lock: Receiver

The receiver synthesiser is unable to lock onto the frequency it is configured to operate at. In response, the base station disabled the receiver.

1. Check that this frequency is within the receiver’s RF frequency range.
2. Do a diagnostic test to determine the lock range, and then check that the frequency is within that range.
3. If the frequency is outside the lock range, use the Calibration Kit to alter the switching range. Otherwise send the reciter for repair.

Power Amplifier

The Power Amplifier area shows the alarm status of the PA associated with the reciter you are logged on to. When a fault is no longer active, any actions (for example, inhibiting transmission) are reversed.

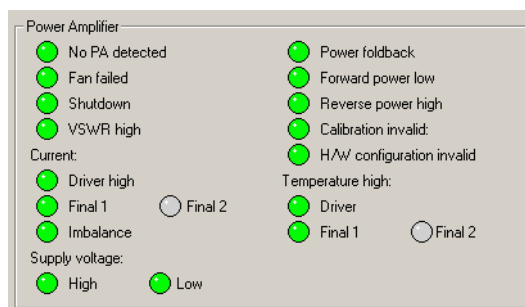

No PA detected

The reciter cannot obtain a response from a PA over the using the [control bus](#). The PA may still be operating but the system has lost the ability to monitor PA alarms, carry out diagnostics, change configuration, or detect PA fan failure.

1. No PA is installed.

2. Your system uses a third party PA which does not use the control bus and cannot respond to the reciter.
3. The control cable or exciter cable is not connected.
4. The PA is faulty and unable to communicate with the exciter.

Fan failed	<p>The PA told the reciter that its fan is on, but the reciter cannot detect fan motion. The base station takes no action when this alarm occurs, but it will act if the PA temperature becomes too high.</p> <p>The fan has failed. Replace it.</p>
Shutdown	<p>The PA has detected a fault condition and has disabled the transmitter to prevent damage. Check the other alarms to see what fault condition or conditions have caused this.</p>
VSWR high	<p>The VSWR is above the configured threshold. A normal VSWR is $\leq 2:1$. A high VSWR automatically means reduced output power. If the VSWR increases to 10:1 or more, the PA folds back its power output to a minimal level. If the VSWR returns to 5:1 or less, the PA recovers.</p> <p>Check for a load mismatch on the PA's RF output.</p>
Power foldback	<p>The PA has detected a fault condition and has reduced its power output to a minimal level to prevent damage.</p> <p>Check the other alarms to see what fault condition or conditions have caused this. If the fault condition clears, the PA automatically returns to its previous power output level and the alarm changes to green.</p>
Forward power low	<p>The PA forward power output is below the configured minimum limit. If the VSWR is also raised, check for a load mismatch. Otherwise, there may be a fault in the output driver(s).</p>
Reverse power high	<p>The PA's reverse power is above the configured maximum. Check for a load mismatch. With a resolution of only 1 W, this alarm is not sensitive if the power output is lower than 20 W. Check the VSWR fault alarm instead.</p>
Calibration invalid	<p>This alarm can only be triggered on startup, when the PA carries out self-tests. It indicates that settings stored in firmware have values outside acceptable limits. In response, the base station disables the transmitter. Re-calibrate the PA using the Calibration Kit or send it to a service center for repair.</p>
H/w configuration invalid	<p>The PA has an invalid hardware configuration. Either the driver is not present or the configuration says that there is a Final 2 output stage but no Final 1, which is impossible.</p>

Current

The Current group of alarms detects excessive or inappropriate current draw. If an alarm shows red, the PA needs servicing.

Alarm	Description
Driver high	The driver is drawing excessive current. A fixed limit has been exceeded.
Final 1	The Final 1 output stage is drawing excessive current. A fixed limit has been exceeded.
Final 2	The Final 2 is drawing excessive current. A fixed limit has been exceeded.
Imbalance	One of the final stages is drawing significantly more current than the other.

Supply voltage

The PA can detect whether its power supply voltage is too high or too low.

Supply voltage high

The PA supply voltage is 29 V or more.

1. The third party power supply is incorrectly configured.
2. A voltage regulator has failed.



Note: The base station is not type-approved for operation when the supply voltage is outside the specified range.

Supply voltage low

The PA supply voltage is 26 V or less, probably because the battery is running low. The fault condition disappears when the voltage exceeds 26.1 V.

Temperature high

This group of alarms shows whether the temperature in the driver, Final 1, or Final 2 output stage has exceeded the configured threshold. If a temperature exceeds a built-in limit, the PA folds back its power output until the temperature is within the normal range.

To see the actual temperatures, select Diagnose > Power Amplifier > Control Tests.

System

The System area displays alarms that are triggered by system conditions. These alarms do not indicate base station faults. You can set a threshold for these alarms if this is appropriate for your system. For example, if the base station should always receive a signal on the balanced input, you can set a threshold so that the alarm is triggered if the signal fails. Otherwise leave the threshold at zero, so that the alarm is never triggered.

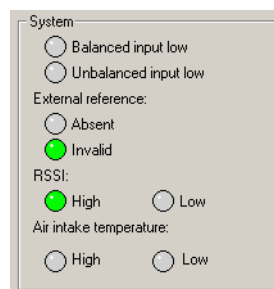

Balanced input low	The audio level on the base station's balanced input lines has fallen below the configured minimum. This alarm can be used to indicate when audio is lost.
Unbalanced input low	The audio level on the base station's unbalanced input lines has fallen below the configured minimum. This alarm can be used to indicate when audio is lost.
External Reference	The base station can detect whether an external reference is present and whether it is useable.
External reference absent	<p>The base station cannot detect an external reference frequency source. It is now using its own source.</p> <ol style="list-style-type: none"> 1. There is no external reference source. Most applications do not need one. 2. The source has become unplugged. 3. The source is not working. <p>An external reference is critical for Quasi-Sync applications.</p>
External reference invalid	<p>An external reference frequency is connected to the base station, but the base station cannot lock on to its channel frequency using that reference. It is now using its own source.</p> <ol style="list-style-type: none"> 1. The base station is configured (Configure > Base Station > General) to expect a 10 MHz frequency, but the source is 12.8 MHz (or vice versa). 2. The reference source is faulty.
RSSI	The base station measures the strength of the incoming RF signal and can determine whether it is stronger or weaker than a pre-defined level.
RSSI high	The signal that the base station is receiving is stronger than the configured maximum.
RSSI low	The signal that the base station is receiving is weaker than the configured minimum.
Air intake temperature	The base station is normally fitted with a sensor that measures the air temperature at the PA fan intake and determines whether it is above or below the configured limits.
Air intake temperature high	The temperature has exceeded the configured maximum. The PA can sustain full-powered continuous operation at an air intake temperature of up to 60° C. Fan operation and PA power foldback are unaffected by this alarm; it is the heatsink temperature, not the air intake temperature, that turns a base station fan on or folds back PA power.
Air intake temperature low	The temperature is below the configured minimum. The base station is not designed for operation below the default minimum.

Power Management Unit

The Power Management Unit area shows the alarm status of the PMU that supplies the base station with power.

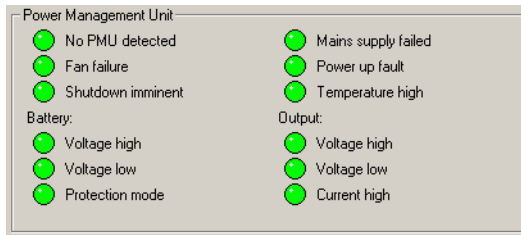

No PMU detected The reciter is unable to detect the PMU on the [control bus](#). There may be a fault or the PMU may still be operating satisfactorily. However, the system has lost the ability to monitor PMU alarms, carry out diagnostics, change configuration, or detect PMU fan failure. Power saving is disabled.

Fan failure The PMU told the reciter that its fan is on, but the reciter cannot detect fan motion. The base station takes no action when this alarm occurs, but it will act if the PMU temperature becomes too high.
The fan has failed. Replace it.

Shutdown imminent This alarm only appears if the PMU has a DC-DC converter and a Standby converter. A battery is currently being used to power the base station and its voltage has fallen to the absolute minimum. The PMU will stop operating 30 seconds after activating this alarm.
The main value of this alarm is as an input for [Task Manager actions](#). You can, for example, have the base station send the [alarm log](#) just before shutting down.

Mains supply failed The mains power supply to the PMU is absent or its voltage is outside acceptable limits. The PMU is using DC power from its battery source.

Power up fault The PMU has detected an internal error and will reset itself. If the reset is successful, the alarm will clear.

Temperature high One of the PMU temperature sensors has detected a temperature that is above the fixed limit.

Battery The PMU measures the voltage of its battery input.

Battery voltage high The PMU's battery voltage is higher than the configured maximum. The base station takes no action until the voltage reaches the fixed maximum, when it shuts down.

Battery voltage low The battery voltage is below the configured minimum. This minimum may have been set to alert you to the risk of damage to the battery from overdischarge. If the voltage falls below a fixed minimum, the PMU automatically shuts down to protect the battery and base station equipment.

Battery protection mode Battery protection mode is on. This happens when a base station is operating on mains power, but the battery voltage is still below the configured minimum. Battery protection mode requires a PMU with a standby converter.

If mains power fails when the PMU is in battery protection mode, the base station shuts down instead of using battery power. This protects the battery.

1. The system has been operating on battery power; the battery has become flat and mains is restored. No action required.
2. The battery is not being charged. Check the PMU's auxiliary output line, if it is being used for charging.
3. The battery is flat. Replace it.
4. The minimum battery voltage is set too high.

Output

The PMU measures the voltage and the amperage of its DC output to the PA and to the reciter.

Output voltage
high

The PMU's DC output (nominally 28 V) is higher than the fixed maximum of 32 V.

Output voltage
low

The PMU's DC output (nominally 28 V) is lower than the fixed minimum of 24 V.

Output current
high

The PMU is providing more than 15 A of current and is automatically limiting its output, lowering the output voltage. There is a short circuit or the PMU is faulty.

Viewing Recent Alarms

The Reported Alarms form (Monitor > Alarms > Reported Alarms) displays recent alarms from the base station you are logged on to. The base station stores the last 50 alarm messages. When you log on, these messages become available and are displayed in this form.



Note: The [Alarm Center](#) can also display recent alarms that have been sent to it by various base stations.

Date & Time	Module	Serial Number	Reported Alarm
2002-08-11 22:05:39	Reciter	18001244	Unbalanced line input low
2002-08-11 22:05:39	Reciter	18001244	Balanced line input low
2002-08-11 22:05:39	Reciter	18001244	RSSI low
2002-08-11 22:05:40	Power Amplifier		Forward power low
2002-08-11 22:05:40	Power Amplifier		Current imbalance
2002-08-11 22:13:31	Reciter	18001244	RSSI low
2002-08-11 22:13:31	Reciter	18001244	Balanced line input low
2002-08-11 22:13:34	Reciter	18001244	Unbalanced line input low
2002-08-11 22:13:34	Reciter	18001244	Balanced line input low
2002-08-11 22:13:37	Power Amplifier		PA final 1 over temperature
2002-08-11 22:13:37	Power Amplifier		PA final 2 over temperature
2002-08-11 22:17:43	Power Amplifier		PA driver over temperature
2002-08-11 22:17:43	Power Managemer	18001010	Mains supply failed
2002-08-11 22:18:21	Reciter	18001244	Balanced line input low
2002-08-11 22:18:21	Reciter	18001244	Unbalanced line input low
2002-08-11 22:18:28	Reciter	18001244	Balanced line input low
2002-08-11 22:18:28	Reciter	18001244	RSSI high
2002-08-11 22:18:29	Reciter	18001244	Unbalanced line input low
2002-08-11 22:18:29	Reciter	18001244	RSSI low
2002-08-11 22:18:36	Reciter	18001244	Balanced line input low
2002-08-11 22:18:36	Reciter	18001244	Exciter synthesiser out of lock
2002-08-11 22:20:18	Power Amplifier		Forward power low
2002-08-11 22:20:18	Power Amplifier		Current imbalance
2002-08-11 22:22:16	Reciter 1	410210	Reciter synthesiser out of lock

The form displays information about the alarms, one row for each alarm. The display is updated with any new alarms each time the Service Kit polls the base station. The polling interval is set when you configure the connection.

Each row contains the following information.

- Date & Time** The date and time that the alarm was reported to the base station (the date is provided by the base station's clock).
- Module** The name of the base station module reporting the alarm.
- Serial Number** The serial number of the module reporting the alarm.
- Reported Alarm** The text of the alarm.

Save to File Click **Save to File** to save the displayed information. This enables you to store a record of alarms, for example, to help with troubleshooting an intermittent problem. The [Alarm log](#) can only store the most recent 50 alarms and these are lost if the base station is reset.

Alarms are stored in CSV format. The default extension is *.csv.

Disabling Unwanted Alarms

You can disable any of the base station's alarms. Some alarms may not be appropriate for your system. For example, the Balanced input low alarm is only helpful if the absence of a line input indicates a system failure.

If you disable an alarm, it does not function in the Service Kit, appear in the alarm log, or turn on the control panel LED. However, Task Manager tasks with that alarm as an input are still processed.

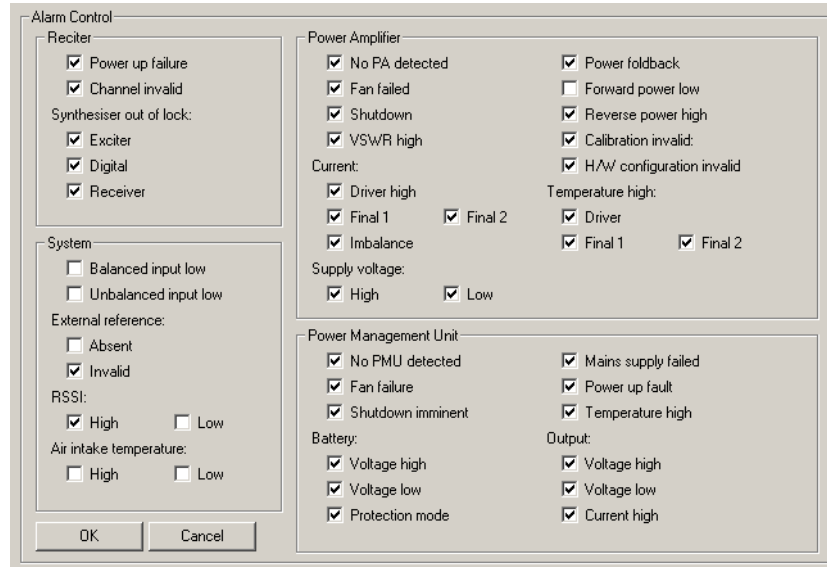

To disable unwanted alarms

1. Select Configure > Alarms > Alarm Control.
2. Clear the check boxes of the alarms to be disabled.
3. Click **OK**.

Altering Alarm Thresholds

The Thresholds form (Configure > Alarms > Thresholds) lets you alter the thresholds for base station alarms.

Some alarm thresholds are fixed; they are built in to the base station and cannot be changed. Others have default values. You may want to adjust them to better reflect your system's operating conditions or monitoring procedures. This can be important if an alarm is used as an input in Task Manager tasks.

Parameter	Value	Unit	Current Value
Minimum PA power output:	10	W	0
Maximum PA reverse power output	50	W	0
Maximum PA VSWR:	1.3	:1	1.1 : 1
Maximum PA final temperature:	50	°C	30
Maximum PA driver temperature:	50	°C	30
PA air intake temperature	Maximum: 20 Minimum: -20	°C	30
PMU battery voltage	Max: 15.5 Min: 11	V	0
Balanced line input level:	Minimum: -20	dBm	-27.07
Unbalanced line input level:	Minimum: 3	Vpp	0.2
BSSI level:	Maximum: -120 Minimum: -120	dBm	-128

The form displays a list of upper and lower limits. Alongside each threshold is the applicable unit. To the right, a box displays the current value of the relevant parameter. When a parameter value goes outside its limit, the base station triggers the corresponding alarm.

To adjust a threshold, edit its value or click one of the adjacent arrows, and then click **OK** to confirm your changes and close the form.

The alarms that these thresholds apply to are described in [“Monitoring Alarms” on page 133](#). The equivalent Task Manager inputs are described in [“Alarm Inputs” on page 186](#).

Minimum PA power output

Defines the lower limit for the PA forward power output. When the output falls below this limit, the base station triggers the alarm [Forward power low](#) and the Task Manager input [Forward power low](#) becomes true.

Maximum PA reverse power output

Defines the upper limit for the PA's reverse power. When the reverse power exceeds this limit, the base station triggers the alarm [Reverse power high](#) and the Task Manager input [Reverse power high](#) becomes true.

When using a 5 W PA, or any PA set to 20 W or less, disable this alarm and use the VSWR alarm instead. The resolution of the reverse power measurement is only 1 W, so the reverse power alarm would only trigger if there is a serious antenna fault. VSWR is calculated with better precision and reliably detects load failure.

Maximum PA VSWR	Defines the upper limit for the VSWR. When the VSWR exceeds this limit, the base station triggers the alarm VSWR high and the Task Manager input VSWR fault becomes true. The hysteresis is fixed at 0.2. For example, if the threshold is 1.5:1, when the VSWR falls to 1.3:1, the alarm is cleared and the Task Manager input becomes false.
Maximum PA final temperature	Defines the upper limit for the operating temperature at the Final 1 and Final 2 stages of the PA. When the temperature exceeds this limit, the base station triggers one of the Temperature high alarms and the Task Manager input PA temperature high becomes true.
Maximum PA driver temperature	Defines the upper limit for the operating temperature at the driver stage of the PA. When the temperature exceeds this limit, the base station triggers one of the Temperature high alarms and the Task Manager input PA temperature high becomes true.
PA air intake temperature	<p>The Maximum box defines the upper limit for the air intake temperature that is measured at the PA. When the temperature exceeds this limit, the base station triggers the Air intake temperature high alarm and the Task Manager input PA air intake temperature high becomes true.</p> <p>The Minimum box defines the lower limit for the air intake temperature that is measured at the PA. When the temperature falls below this limit, the base station triggers the Air intake temperature low alarm and the Task Manager input PA air intake temperature low becomes true.</p>
PMU battery voltage	<p>The Max box defines the upper limit for the battery voltage that is supplied to the DC-DC converter. Different limits apply, depending on which nominal voltage the DC-DC converter is designed for. When the voltage exceeds the relevant limit, the base station triggers the Battery voltage high alarm and the Task Manager input Battery voltage high becomes true.</p> <p>The Min box defines the lower limit for the battery voltage that is supplied to the DC-DC converter. Different limits apply, depending on which nominal voltage the DC-DC converter is designed for. When the voltage falls below the relevant limit, the base station triggers the Battery voltage low alarm and the Task Manager input Battery voltage low becomes true.</p> <p>Both the upper and lower limits have a hysteresis of 0.1 V.</p>
Balanced line input level	The Minimum box defines the lower limit for the level of the audio signal on the balanced line in. When the audio level falls below this limit, the base station triggers the Balanced input low alarm and the Task Manager input Balanced input low becomes true.
Unbalanced line input level	The Minimum box defines the lower limit for the level of the audio signal on the unbalanced line in. When the audio level falls below this limit, the base station triggers the Unbalanced input low alarm and the Task Manager input Unbalanced input low becomes true.
RSSI level	<p>The Maximum box defines the upper limit for the received signal strength as measured in the receiver. When the RSSI exceeds this limit, the base station triggers the RSSI high alarm and the Task Manager input RSSI high becomes true.</p> <p>The Minimum box defines the lower limit for the received signal strength as measured in the receiver. When the RSSI falls below this limit, the base station triggers the RSSI low alarm and the Task Manager input RSSI low becomes true.</p>

Notifying Alarms

The Notification Methods form lets you configure the way the base station lets you know over the air and over the line that there is an alarm.



Important: Configuring these notification methods does not enable notification. This is done by Task Manager tasks that must be configured for your system.

Base stations with an Alarm Reporting license can send alarms to an Alarm Center and status messages (which contain the current state of all alarms and the [alarm log](#)) via email.

Notifying Over the Air

The Service Kit lets you configure the way the base station notifies alarms using the base station's own transmissions. To start and stop the over-the-air alarm, set up Task Manager statements. See “[Over the air alarm actions](#)” on page 197.

Over the air

Type: Pip Tones

Pip method: Tail Transmission

Pip interval: 10 sec

Pip level: 0 dB



Tip: Use [CWID](#) as an additional over-the-air alarm notification method. Task Manager can disable CWID on startup, and then enable it when particular alarm conditions occur. See “[CWID Actions](#)” on page 195.

To configure the over-the-air alarm

1. Select Configure > Alarms > Notification Methods.
2. In the Over the air area, **Type** box, select an alarm type. Currently, only Pip Tones are available. A pip tone is a 600 Hz tone with a duration of 200 ms.
3. In the **Pip method** box, select an option that specifies how the pip tones are transmitted.

Option	Description
Tail transmission	A single pip tone is transmitted at the end of every transmission.
Periodically with Tx	A pip tone is transmitted at the beginning of each transmission and regularly during the transmission at the interval specified by the Pip interval box.
Periodically with no Tx	A pip tone is transmitted regularly when the base station is not otherwise transmitting. Pip tones are transmitted at intervals specified by the Pip interval box.

4. In the **Pip interval** box, specify the interval between pip tone transmissions.
5. In the **Pip level** box, specify the level of the pip tones in dB. This is the level relative to speech. More precisely, it is relative to the maximum transmit deviation of the current channel.
6. Click **OK** to confirm your changes and close the form.

Notifying Over the Line

The Service Kit lets you configure the way the base station notifies alarms over its balanced or unbalanced line interface. To start and stop the over-the-line alarm, see [“Over the line alarm actions” on page 197](#).

The screenshot shows a dialog box titled "Over the line" with the following configuration:

- Type: Pip Tones
- Pip method: Tail Transmission
- Pip interval: 10 sec
- Pip level: 0 dB

To configure the over-the-line alarm

1. Select Configure > Alarms > Notification Methods.
2. In the Over the line area, **Type** box, select an alarm type. Currently, only Pip Tones are available. A pip tone is a 600 Hz tone with a duration of 200 ms.
3. In the **Pip method** box, select an option that specifies how the pip tones are sent.

Option	Description
Tail transmission	A single pip tone is sent down the line at the end of every transmission
Periodically with Tx	A pip tone is sent down the line at the beginning of each transmission and regularly during the transmission at the interval specified by the Pip interval box.
Periodically with no Tx	A pip tone is sent down the line regularly when the base station is not transmitting RF. Pip tones are transmitted at intervals specified by the Pip interval box.

4. In the **Pip interval** box, specify the interval between pip tone transmissions.
5. In the **Pip level** box, specify the level of the pip tones in dB. This level is relative to the line level specified in the channel profile for the current channel.

Configuring Alarm Center Communications

If the base station has a dial-up modem and is able to connect via a telephone line to a PC running the Tait [Alarm Center](#) program, you need to enable and configure that connection.

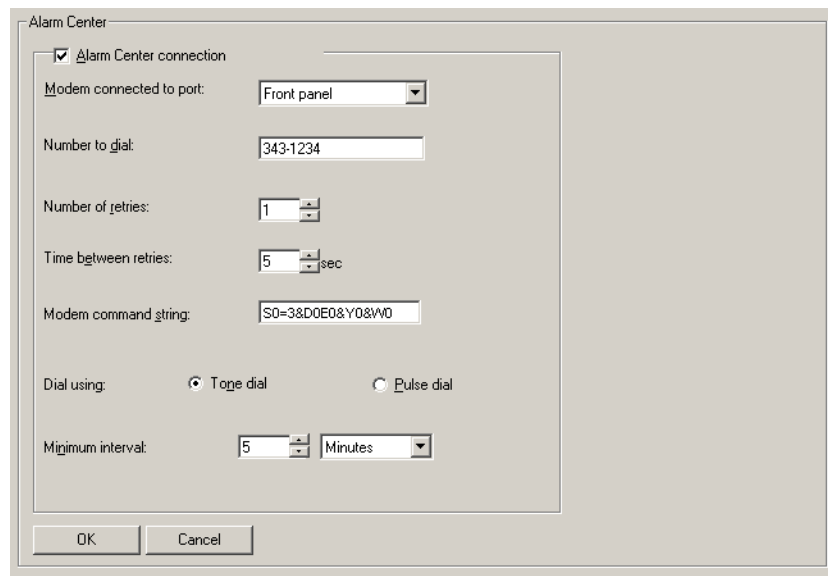

To configure base station communications with an Alarm Center

1. Select Configure > Communications > Alarm Center. The Alarm Center form appears.
2. Select the **Alarm Center connection** check box.
3. Specify which base station serial port will be used. (Currently, Front panel is the only option.)
4. In the **Number to dial** box, enter the telephone number of the Alarm Center computer's modem.
5. In the **Number of retries** box, specify the number of times that the base station will attempt to connect to the Alarm Center before giving up.



Note: Make sure that this number is sufficiently high. If the Alarm Center is connected to another base station or if it is sending an email over its modem, the dial-up will fail and the base station must retry. For an Alarm Center with n base stations, it is a good idea to have $n + 1$ retries.

6. In the **Time between retries** box, specify the length of time that the base station will wait before trying again to connect to the Alarm Center.
7. In the **Modem command string** box, specify any command string that is to be sent to the base station's modem to configure it and prepare it for dialling.
8. Specify whether the base station modem is to use tone dialling or pulse dialling. Most modern telephone systems use tone dialling.

9. In the **Minimum interval** box, specify the minimum time that must elapse after the base station sends an alarm log or email message before it can send another. Select a number and specify whether it is minutes or hours. Make sure that the interval is large enough to prevent the base station keeping the Alarm Center busy when other base stations are trying to contact it.
10. Click **OK** to confirm your changes and close the form.
11. Create suitable Task Manager tasks that instruct the base station to send the alarm log or status message, using the action **Send alarm log now**.

Configuring Email Messaging

If the base station has an Alarm Reporting license and is set up with a dial-up connection using a telephone line, it can email alarms, for example, to the maintenance technician's PC.

The Email form lets you enable and configure the sending of email messages. The base station passes the configuration information on to its Alarm Center along with the status message. The Alarm Center then builds the email using that information and sends it to the SMTP server address provided.

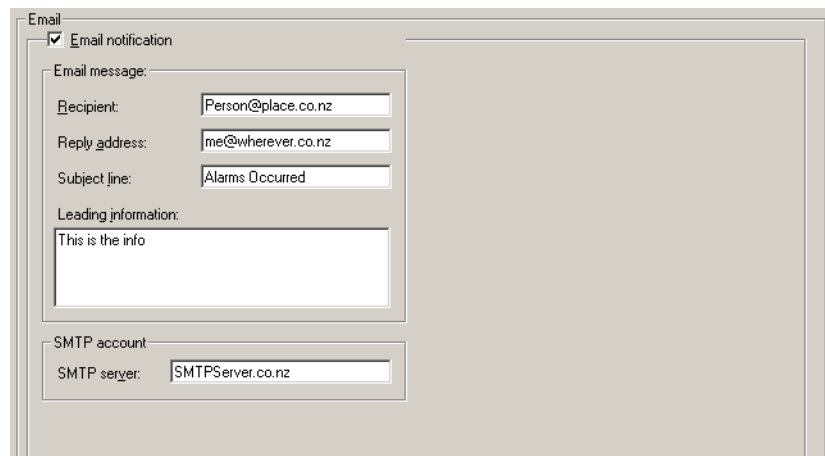

The screenshot shows a configuration window titled "Email". At the top, there is a checked checkbox for "Email notification". Below this, the "Email message:" section contains four input fields: "Recipient" with the value "Person@place.co.nz", "Reply address" with "me@wherever.co.nz", "Subject line" with "Alarms Occurred", and "Leading information" with "This is the info". At the bottom, there is an "SMTP account" section with an "SMTP server" input field containing "SMTPServer.co.nz".

To configure email messaging

1. Select Configure > Communications > Email.
2. Select the **Email notification** box to enable the base station to send emails via an Alarm Center.
3. In the **Recipient** box, enter the email address of the person to receive the email. If you want emails to be sent to multiple addresses, separate the addresses with a comma.
4. In the **Reply address** box, enter an email address for replies. The base station itself cannot receive replies to the emails it sends; they will go instead to this address.
5. In the **Subject line** box, enter the text for the subject of the emails.
6. In the **Leading information** box, enter text that will be added to the message body before the actual content of the email.
7. In the **SMTP server** box, enter the IP address of the server that the Alarm Center will send emails to.
8. Set up suitable Task Manager actions that send email in response to appropriate events.



Tip: Select Diagnose > Reciter > Misc I/O and send a test email to verify that the configuration works.

Part H Diagnosing

Using the Service Kit, you can carry out diagnostic tests on the base station and its modules. While you can view a diagnostic form in Run mode, the base station must be in Standby mode for the test itself.

Generally a diagnostic form displays relevant information, so that you can monitor base station status before, during, and after the test. Often you can combine different tests.

Some diagnostic tests check aspects of the base station. Others provide you with a simple function (for example, a voltage on the RSSI output pin) that facilitates setting up or troubleshooting the base station's interface to external equipment.

Topics

- [Carrying Out Diagnostic Tests](#)
- [System Tests](#)
- [Reciter Tests](#)
- [Power Amplifier Tests](#)
- [Power Management Unit Tests](#)

Carrying Out Diagnostic Tests

Most diagnostic tests are carried out in a similar way. The following describes how to do it.

When you start a test, it uses the base station's existing settings such as frequency and level, unless you enter different values. When you stop a test or it comes to an end, the base station always returns to the configuration it was in before the test began. For example, after making a test transmission at a manually selected frequency, the base station reverts to the frequency it was previously configured for.

To carry out a diagnostic test

1. Connect and log on to the base station. You can be remotely connected, but you do need to be on site to test the control panel and the speaker.
2. Click **Diagnose**.
3. Click **Mode** and select Standby mode.
4. In the navigation pane, select an item. The corresponding form appears.
5. In the form, check the base station's current status and click **Start Test**.

This either carries out the test or it enables other buttons on the form so that you can carry out a test. The item in the navigation pane turns red and the Start Test button changes to Stop Test.

During the test, the base station will respond to any faults that occur (if, for example, the PA overheats, it will fold the power back) but there will be no alarm notification, because Task Manager is not active in Standby mode.

6. If desired, you can navigate to other forms to view monitoring screens, check the base station's configuration. Some tests also allow you to simultaneously carry out other tests.
7. If necessary, click **Stop Test** to end the test (some tests end automatically). Selecting Run mode or disconnecting the Service Kit also ends the test.

System Tests

The Service Kit can initiate self-tests on the base station you are logged on to and verify that the control panel controls are working.

Self-Tests

In the Self Tests form (Diagnose > System > Self Tests), you can ask the base station to carry out a set of self-tests. The base station itself determines whether it passes a test. The form displays the result of those tests.

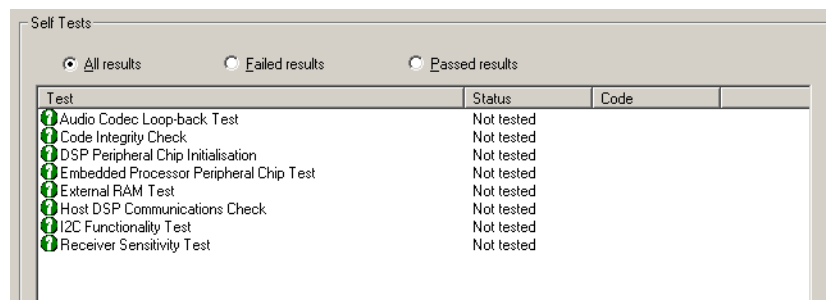

The screenshot shows a window titled "Self Tests" with three radio buttons: "All results" (selected), "Failed results", and "Passed results". Below the buttons is a table with the following data:

Test	Status	Code
1 Audio Codec Loop-back Test	Not tested	
1 Code Integrity Check	Not tested	
1 DSP Peripheral Chip Initialisation	Not tested	
1 Embedded Processor Peripheral Chip Test	Not tested	
1 External RAM Test	Not tested	
1 Host DSP Communications Check	Not tested	
1 I2C Functionality Test	Not tested	
1 Receiver Sensitivity Test	Not tested	

You can use the option buttons to configure the display to show all test results, only tests that failed, or only tests that passed.

To run base station self-tests

1. Click **Run Tests**. The tests can take up to 90 seconds. When the tests are completed, the Self Tests form displays the results.
2. If the base station fails a test, click **Reset Base Station** (Administrator access level required). This may enable the base station to recover. You need to connect the Service Kit again and log on to the base station.
3. Click **Run Tests** again. If the base station still does not pass the tests, note any failure codes displayed in the Code column and send the base station for repair.

Control Panel Tests

The Control Panel form (Diagnose > System > Control Panel) lets you carry out tests to verify that the controls on the front of the BSS are working. You need to be at the base station site to carry out these tests. The base station can test all controls, including those used by the other channel.

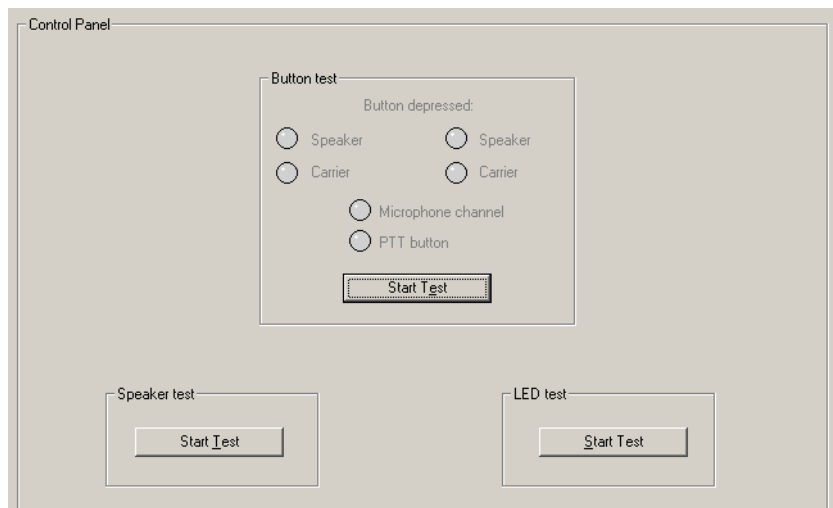

To test control panel buttons

1. In the Button test area, click **Start Test**. This disables all control panel functions. The base station will now pass control panel inputs to the Service Kit.
2. Press a button on the control panel.
3. Check that the corresponding LED in the Service Kit form turns green.
4. Repeat steps 2 and 3 for each other button you want to test.
5. Click **Stop Test** to conclude the test.

To test the microphone's PTT button

1. In the Button test area, click **Start Test**. This disables all control panel functions. The base station will now pass any control panel inputs to the Service Kit.
2. Press the PTT button on the microphone.
3. Check that the PTT button LED in the Service Kit form turns green.
4. Click **Stop Test** to conclude the test.

To test the speaker

1. In the Speaker Test area, click **Start Test**.
2. Turn up the volume and listen to confirm that a 700 Hz test tone at 0 dBm is coming from the speaker.
3. Click **Stop Test** to conclude the test.

To test the control panel LEDs

1. In the LED test area, click **Start Test**.
2. Check that each of the control panel LEDs is going on and off in a recognisable sequence.
3. Click **Stop Test** to conclude the test.

Reciter Tests

The Service Kit lets you carry out tests on the receiver, synthesiser lock ranges, audio lines, and the various digital inputs and outputs.

Receiver Tests

The Receiver form (Diagnose > Reciter > Receiver) lets you carry out various tests on the receiver part of the TB8100 reciter.

Testing Receiver Operation

The Set receiver frequency test provides a quick way to get the receiver operating. You manually set the receiver frequency and do not need to alter the base station's configuration.

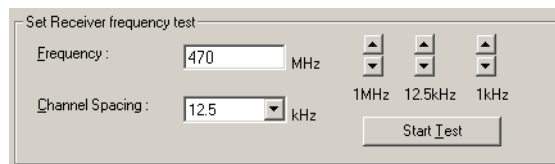

1. Connect an RF source to the reciter.
2. Select Diagnose > Reciter > Receiver. In the **Frequency** box, enter the frequency you want to receive on. Alternatively, use the arrow buttons to shift the frequency up or down.
3. In the **Channel Spacing** box, select a value from the drop-down list.
4. Click **Start Test**.

In the Receiver Values area, a green LED indicates whether the receiver synthesiser managed to lock onto the frequency. The area also displays the current RSSI and SINAD and the receiver's operating frequency.

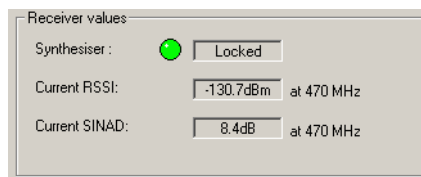

5. If there is no response, check the **Receiver state** LED and box to verify that the receiver is on. If it is not on, the **Exciter state** LED and box indicate whether the whole reciter is off.



Note: The SINAD is approximate and is obtained by comparing the in-band audio against out-of-band noise. This value should not be relied upon to make calibrated measurements.

6. If desired, unmute the receiver output as follows:
 - a. In the Control area, click **Start Test**.
 - b. Click **Unmute Output**.
7. If desired, modify the receive frequency by clicking the up or down arrows. (You can repeat this as often as you want.)

The End Test button turns into a disabled Starting Test button until the new frequency has been tested. The form now displays the new values.

8. Click **Stop Test** when you are finished.

Testing Receiver Sensitivity

You can carry out a basic test of the receiver's [sensitivity](#) without using test equipment. The test only works if the receiver has a 50 ohm load and is not receiving any RF signal. You can set this up by connecting up a test set and switching its RF off.

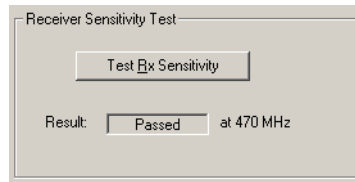

1. Disconnect the antenna and connect a 50 ohm load.
2. Select Diagnose > Reciter > Receiver.
3. If necessary, alter the receiver's frequency and channel spacing in the **Set receiver test frequency** area.
4. Click **Test Rx Sensitivity**. The Result box indicates whether the receiver passed or failed the test. If the receiver was receiving any RF, the test result will be 'fail.'

Measuring Received Signal Levels

You can measure the strength of RF signal that the base station receives across a band of frequencies. A bar graph displays the results.

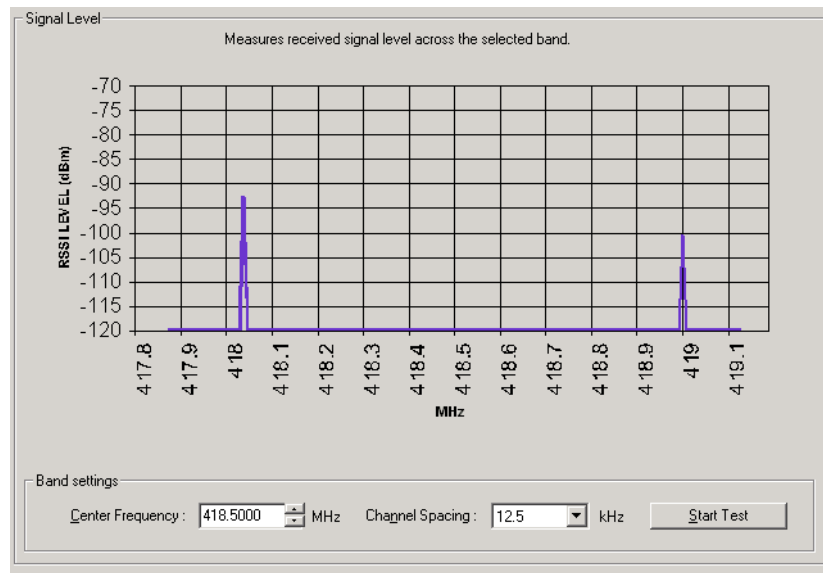

This test lets you see what signals are out there; it does not determine the receiver's sensitivity.

To measure signal levels

1. Select Diagnose > Reciter > Signal Level.
2. In the **Center frequency** box, specify the middle frequency of the band you want to test. This can be any frequency within the receiver's [switching range](#).
3. In the **Channel spacing** box, select a value from the drop-down list. This specifies the size of the step from one frequency to the next. If this corresponds to the channel spacing, you will measure signal levels of the different channels in the band.
4. Click **Start Test**. The base station sets the receiver to a frequency, measures the RSSI, increments the frequency by the value in the Channel spacing box, measures its RSSI and so on for 101 steps below and above the center frequency you specified.

When the test is complete, the graph displays the measured RSSI values and annotates the x-axis with the correct frequency values. The data is automatically saved to a file (signal_level_log.csv) in the LogFiles subdirectory. You can open this file in a spreadsheet program.

Determining Synthesiser Lock Ranges

You can test the reciter's synthesisers to determine the range of frequencies that the receiver and the exciter can operate on. Use these tests to check that the reciter is calibrated correctly for the channels that it will operate on.

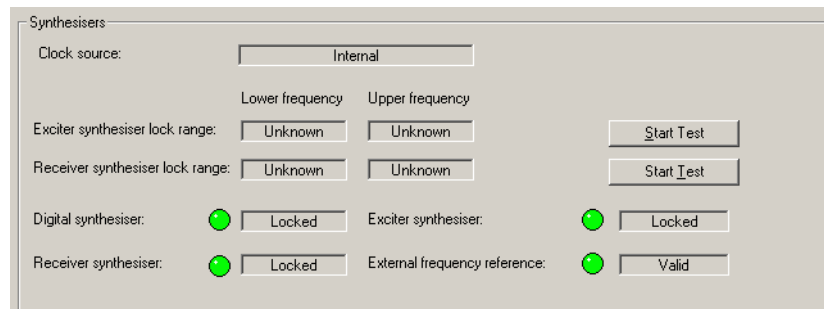

The **Clock source** box indicates whether the reference frequency is internal or external to the base station.

The bottom group of boxes with LEDs indicate the lock status of various parts of the reciter in its current operation.

To test the exciter or receiver lock range

1. Select Diagnose > Reciter > Synthesisers.
2. Click **Start Test** in the exciter or receiver row.

The exciter or receiver checks all the channel frequencies in the band that the base station is type-approved to operate in.
3. In the **Lower Frequency** and **Upper Frequency** boxes, view the results of the test. These values report the range within which the synthesiser is able to lock onto the specified frequency.



Note: The reported ranges are conservative. In fact, the base station will be able to transmit and receive outside the range, but with reduced transmit output and receive sensitivity.

4. Click **Stop Test**. The exciter and receiver frequencies revert to what they were when you started the test.

Audio I/O Tests

The Audio I/O form (Diagnose > Reciter > Audio I/O) lets you measure the level of any audio input or put a 0 dBm signal tone on the balanced or unbalanced line out.

In the Input area, the **Audio Input** gauge displays the level of the current audio input. In the Output area, the **Audio Output** gauge displays the audio level of the line out selected by the option buttons. The display continues to update every 500 ms.

Measuring the Audio Input Level

The reciter can measure the level of the current audio input and display it on the Service Kit.

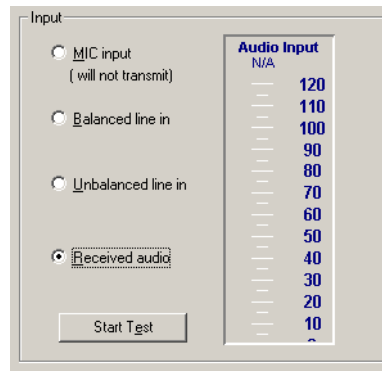

You can use this diagnostic tool in the following situations:

- Troubleshooting: the measurement shows you whether audio is arriving at the base station.
- Adjusting the audio output of other equipment such as a console.
- Defining channel profiles: the measurement tells you the actual input level so that you can specify a value for the expected input level.



Note: Audio that is input during the test is not transmitted, because the base station goes into standby mode for the test.

To measure the audio input level

1. Make sure that audio is being fed into one or more inputs on the reciter's system interface.
2. Select Diagnose > Reciter > Audio I/O.
3. Click the appropriate option to select the type of input you want to measure.
4. In the Input area, click **Start Test**.

The **Audio Input** gauge displays the audio level. The numeric value of the level appears under the gauge heading. The value is displayed in red if it is off the scale of the gauge. Levels are measured over a window of 100 ms and updated twice a second.

5. Click **Stop Test** or return to Run mode to end the test.

Generating an Audio Output

The reciter can output an audio test tone at one of three pre-defined frequencies. You can use this to test the reciter's ability to put audio on its output lines or to set up and configure the interface from external equipment to the base station. The audio is output at a nominal 0 dBm.

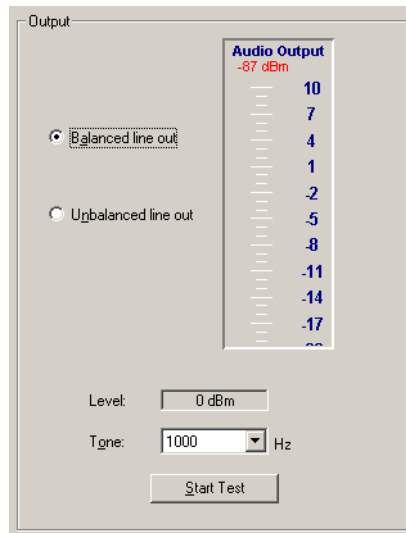

1. Select Diagnose > Reciter > Audio I/O.
2. In the Output area, specify which line out will carry the output.
3. Click **Start Test**.
4. View the **Audio Output** gauge and check that the measured level is close to 0 dBm (balanced line out) or 0.8 Vpp (unbalanced line out).
5. Click **Stop Test** or return the base station to Run mode to end the test.

Digital I/O Tests

The Digital I/O form (Diagnose > Reciter > Digital I/O) lets you work with digital inputs and outputs. You can view the current state of all digital inputs and toggle any digital output to help you test any equipment connected to it.

The **Channel switch** area indicates the channel number that is currently set by external equipment using the channel select lines on the system interface. If the area is disabled, this is because external channel selection is disabled (Configure > Base Station > System Interface.)

The **Digital outputs** area lets you toggle any digital output between **active** (red LED) and **inactive** (gray LED). You can do the same to the Rx Gate output.

The **Digital inputs** area displays the current settings of digital inputs. You can also view the current state of the Tx Key input.

Testing Digital Outputs

You can toggle any digital output line or the Rx Gate output line between [active](#) and [inactive](#). Use this test to make sure that the output is working and to check that any equipment attached to that output responds as intended.

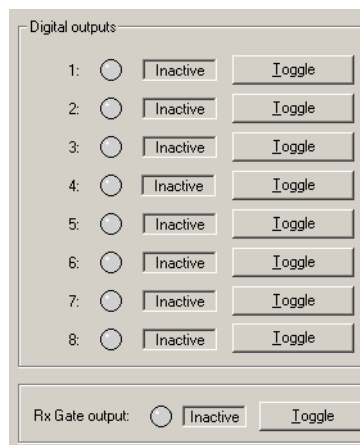

To test a digital output

1. Select Diagnose > Reciter > Digital I/O.
2. Click **Start Test**. This enables the Toggle buttons in the Digital Outputs area. This area now displays the output states as they were when you started the test.
3. Click the digital output's (or Rx Gate's) **Toggle** button to change its state. When the output is activated, its LED displays Green. (If the output is not present on the system interface board, an error message appears.)
4. Check the response of any attached equipment.

When you have finished testing the outputs, click **Stop Test**. This returns all digital outputs to the state they were in when you started the test.

Testing Digital Inputs

The Digital inputs area displays the current state of all digital inputs to the reciter.

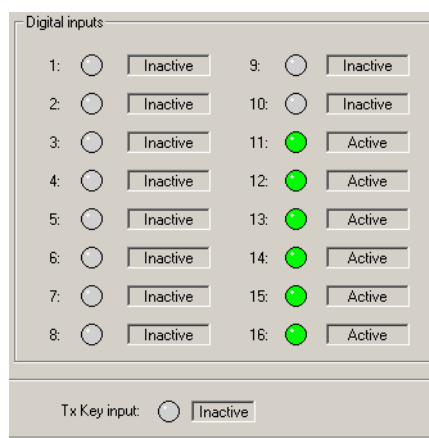

A digital input can be **active** (red LED) or **inactive** (gray LED). Many of these inputs can be configured as channel select lines. The Channel box indicates the channel number that they currently select and the text to the right indicates the number of bits (lines) involved and their logic settings.

To test a digital input

1. Select Diagnose > Reciter > Digital I/O.
2. Using the equipment connected to the digital input, toggle the state of that input.
3. In the Digital inputs area, check that the state of that input changed.

Testing Hardware Channel Selection

If the channel that the base station operates on is to be selected by an external channel switch, you can verify that the base station correctly interprets the switch's channel selection.

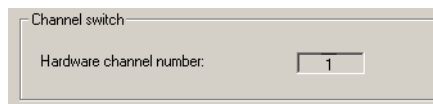

1. Select Diagnose > Reciter > Digital I/O.
2. Using the channel switch, select a channel.
3. In the Channel switch area, check that the expected channel number appears. (A hardware channel number of 0 means that the channel is defined by software.)
4. If there is a discrepancy, check that the correct channel selection option (Binary, **BCD**, or invert) is selected in Configure > Base Station > System Interface.

Miscellaneous Tests

The Misc I/O form (Diagnose > Reciter > Misc I/O) lets you test the RSSI output and send a test email.

RSSI Tests

In the Misc I/O form, the RSSI output area lets you carry out tests on the RSSI output. You can:

- provide a defined RSSI voltage output so that you can test equipment that is connected to the base station.
- specify a received signal strength in dBm and test the base station's conversion of the measured signal strength into an output voltage. You can use this test to convert an RSSI voltage to received dBm or vice versa.

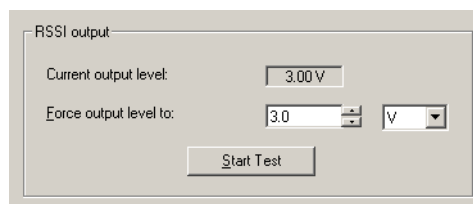

The **Current output level** box displays the voltage currently on the RSSI output pin.

Setting a Fixed RSSI Voltage

1. Select Diagnose > Reciter > Misc I/O.
2. In the **Force output level to** box, enter the voltage level you want.
3. In the adjacent box, select V.
4. Click **Start Test**. This unlinks the RSSI output pin from the reciter's operating logic. The RSSI output pin is initially set to 0 V, and then the test puts the selected voltage directly on the RSSI output pin.
5. Click **Stop Test** to stop the test. This gives control of the RSSI output back to the base station.

Testing the RSSI Output

1. Select Diagnose > Reciter > Misc I/O.
2. In the **Force output level to** box, enter a nominal received signal strength in dBm.
3. In the adjacent box, select dBm.
4. Click **Start Test**. This unlinks the RSSI output pin from the reciter's operating logic.

The RSSI output pin is initially set to 0 V, and then the test uses the configuration in Configure > Base Station > System Interface to calculate a voltage from the signal strength you specified and put it on the RSSI output pin.

5. Using test equipment, measure the voltage on the RSSI output pin and confirm that it is as you would expect. Also check the voltage in the **Current output level** box.
6. Click **Stop Test** to stop the test. This gives control of the RSSI output back to the base station, which updates the voltage with a value computed from the currently measured received signal strength.

Sending a Test Email

1. Select Diagnose > Reciter > Misc I/O.
2. In the Email area, click **Start Test**. The base station sends a test email using the configuration in Configuration > Communications > Email.

Detecting Subaudible Signalling

You can monitor the current channel for any subaudible signalling. This is a useful diagnostic tool if the base station is not opening the receiver gate to transmissions with subaudible signalling as expected.

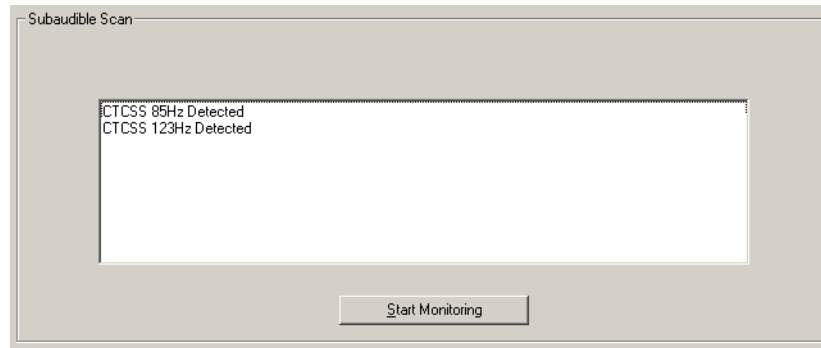

To detect subaudible signalling

1. Select Diagnose > Reciter > Subaudible Scan.
2. Click **Start Monitoring**.

The form will now display the type and modulation frequency of any subaudible signalling that the base station receives.

Power Amplifier Tests

The Service Kit lets you test aspects of the PA. You can test the fan, the front panel, and the PA's ability to transmit.

Control Tests

The Control Tests form (Diagnose > Power Amplifier > Control Tests) lets you test the PA fan and front panel fault LED.

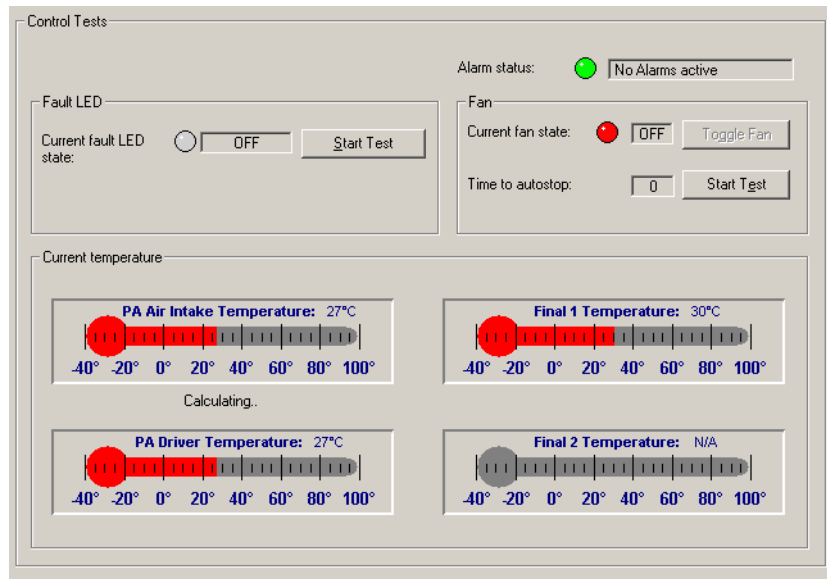

Alarm status	Indicates whether the PA has any current alarms.
Current fault LED state	Indicates the current state of the LED and the fan, and lets you test them.
Current temperature	The Current temperature area displays four thermometers that monitor the four PA temperature sensors.

Testing the PA Fault LED

You can test that the LED on the front of the PA is able to light up. (This LED is only visible when the front panel is removed.)

1. Select Diagnose > Power Amplifier > Control Tests.



2. Click **Start Test**. This uncouples the fault LED from the PA's operational logic.
3. Click **Toggle LED**. If the fault LED was off, this should turn it on.

4. Check that the PA LED is on.

After five seconds, the test ends and the LED's connection with the PA is restored.

Testing the Fan

You can ask the base station to turn the PA fan on and off. This tests the fan and its control circuitry.

Test the fan after fixing a fan problem or fitting a new fan. When you fit a fan, use this test to verify that the fan is correctly connected, so that the PA (and not the PMU) activates it.



Note: The base station can detect the motion of 3-wire fans and will raise an alarm if the fan does not operate.

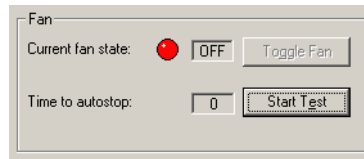

To test the fan

1. Select Diagnose > Power Amplifier > Control Tests.
2. Click **Start Test**. This uncouples the fan from the base station's control but leaves it in its current state.
3. Click **Toggle Fan**. If the fan was off, this should turn it on.
4. Check that the fan is operating. A 5-second timer counts down. When it expires, the test ends and control of the fan reverts to the base station.

Testing the Transmitter

The Transmission Tests form (Diagnose > Power Amplifier > Transmission Tests) lets you test the ability of the PA to transmit. Use it, for example, when setting up and commissioning a system. You can:

- transmit using the current channel configuration
- specify any suitable frequency, and configure the output power and channel bandwidth.
- transmit carrier only or carrier modulated by your choice of modulation frequency and deviation level.



Tip: Alternatively, test the transmitter by pressing the Carrier button on the control panel.

To ensure that you cannot inadvertently leave the base station transmitting, the test automatically stops after 60 seconds.



Note: You can carry out this test together with other tests, for example to see the effect of transmission on battery voltage when the mains supply is off.

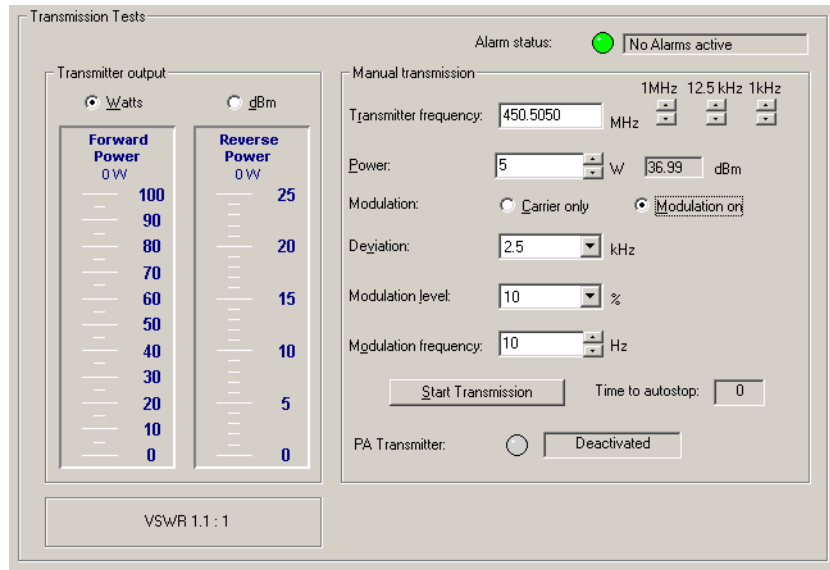

Transmitter output

The Transmitter output area displays forward and reverse power gauges, and you can choose whether to view the values as watts or dBm. Underneath is the [VSWR](#).

Alarm status

If the Alarm status LED is red, there is a PA alarm and you cannot carry out the test.

Manual transmission

The Manual transmission area lets you configure and carry out the transmission test.

To send a test transmission

1. If you don't want to use the current channel configuration, specify the frequency and power of the test transmission as follows:
 - a. In the **Transmitter frequency** box, enter a frequency or use the arrows to increment or decrement the current frequency.



Important: Do not inadvertently transmit on a prohibited frequency. For example, 406.0–406.100 MHz is reserved internationally for distress beacons.

- b. In the **Power** box, specify the RF output power that the test will run at. The box to the right displays the equivalent power in dBm.
2. If you want to transmit an unmodulated test signal, select the **Carrier only** option.
3. If you want to transmit a modulated test signal, select the **Modulation on** option, and configure the modulation as follows:
 - a. In the **Deviation** box, select a maximum transmit deviation.
 - b. In the **Modulation level** box, specify what percentage of the maximum deviation the test tone will have.
 - c. In the **Modulation frequency** box, specify the frequency of the tone that will modulate the test signal.
4. Wait until the **PA transmitter** LED is gray (this means that the base station is not busy).

5. Click **Start Transmission**.

The PA outputs an RF signal on the RF Out N-connector. The **Transmitter output** area gives you a graphical display of the forward and reverse power.

6. Click **Stop Transmission** at any time to end the test.

If you don't end the test, it automatically stops when the **Time to autostop** box has counted down to zero. If the transmission time was not long enough, click **Start Transmission** again.

Power Management Unit Tests

The Service Kit lets you test aspects of the PMU and monitor additional details of its operation.

Control Tests

The Control Tests form lets you simulate a mains failure. You can also check that the fan, the fault LED, and the auxiliary output are working.

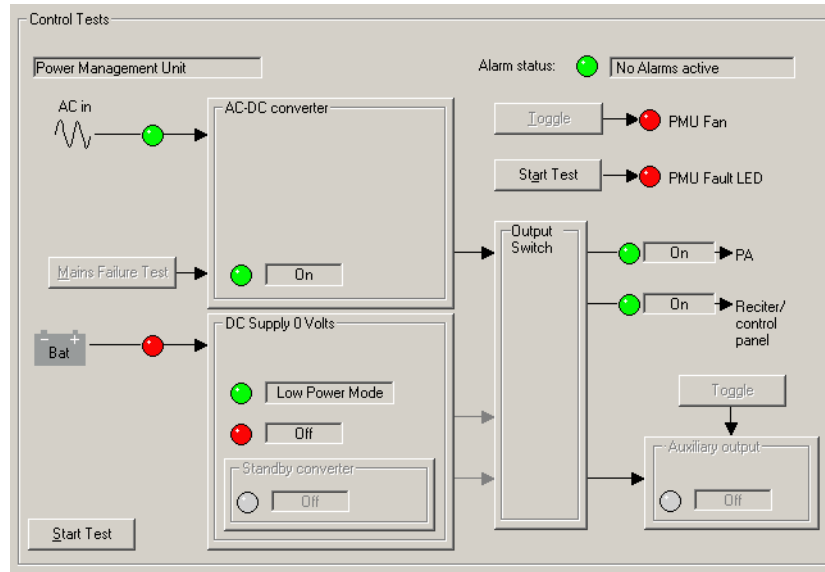

Simulating Mains Failure

The Control Tests form lets you simulate a mains failure so that you can test the BSS's battery backup and the PMU's DC-DC converter.



Important: This test affects any other base station in the BSS.



Important: This test will shut the whole BSS down if there is no backup power supply.

To simulate mains failure

1. Select Diagnose > Power Management > Control Tests.
2. Click **Start Test** at the bottom of the Control Tests form.
3. Click **Mains Failure Test**.
4. Check that power to the PA and the Reciter/control panel stays on.

Testing the Fan

You can ask the base station to turn the PMU fan on and off; this tests the fan and its control circuitry.

Test the fan after fixing a fan problem or fitting a new fan. When you fit a fan, use this test to verify that the fan is correctly connected, so that the PA and not the PMU activates it.



Note: The base station can detect the motion of 3-wire fans and will raise an alarm if the fan does not operate.

To test the fan

1. Select Diagnose > Power Management > Control Tests.
1. Click **Toggle** to the left of the PMU fan LED. If the fan was off, this should turn it on.
2. Check that the fan is operating.
After ten seconds, the test automatically ends and the base station takes back control of the fan.

Testing the PMU fault LED

You can test that the fault LED on the front of the PMU is able to light up. (This LED is only visible when the front panel is removed.)

1. Select Diagnose > Power Management > Control Tests.
2. Click **Start Test** to the left of the PMU fault LED. This uncouples the LED from the PMU's operational logic.
3. Check that the PMU LED flashes on and off. (The control panel LED should also light up, unless all PMU alarms are disabled.)
4. Click **Stop Test** to restore the LED's connection with the PMU.

Testing the Auxiliary Power Output

If the PMU is fitted with an auxiliary power supply submodule, you can test the PMU's ability to switch its output on and off.



Note: The auxiliary power output must be on. If it is configured to be on only when the PMU uses mains power, make sure that the PMU is not using battery power.

1. Select Diagnose > Power Management > Control Tests.
2. Click **Start Test** at the bottom of the form.
3. Click the **Toggle** button above the Aux Output box.
The state of the LED should change.
4. Click **Stop Test**.

Viewing Additional Details

The Supply Tests form (Diagnose > Power Management Unit > Supply Details) provides some additional information about the PMU.

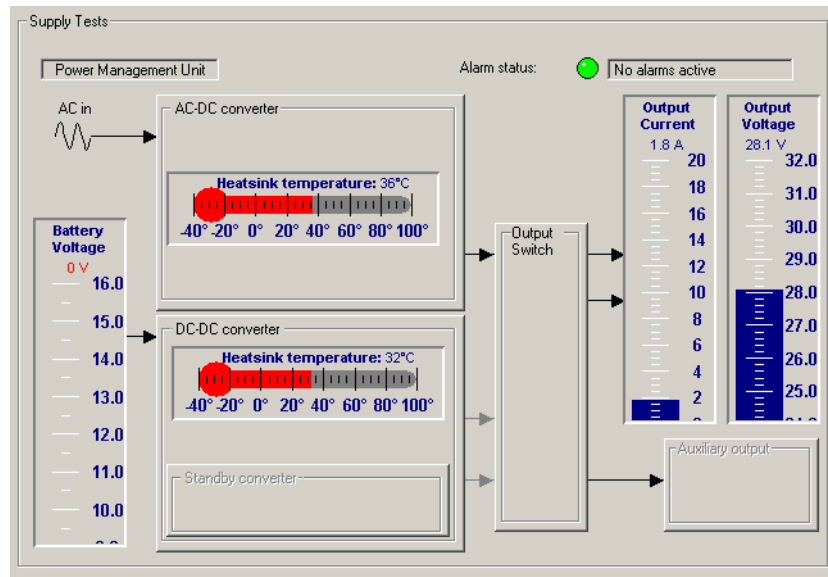

The form has a thermometer for each heatsink temperature sensor and an output voltage gauge. It also shows you all the monitoring information in Monitor > Monitoring > Power Management.

Part I Task Manager

The Service Kit is your window into Task Manager. You can view the list of tasks, create new tasks from the available list of inputs and actions, and create custom inputs and actions.

You can also monitor recent Task Manager actions and disable any tasks that may be causing problems.

Topics

- [About Task Manager](#)
- [Accessing Task Manager](#)
- [Working With Task Manager](#)
- [Inputs](#)
- [Actions](#)
- [Task Manager Examples](#)
- [Customizing Task Manager](#)
- [Monitoring Task Manager](#)

Accessing Task Manager

There are several different ways to access Task Manager forms. The different forms arrange the tasks differently, to present you with the most appropriate grouping of tasks for the part of the Service Kit you are currently in. For example, if you open Task Manager from the Alarms section of the Configuration navigation tree, tasks relating to alarms are shown, and other tasks are hidden in folders. You can always access all tasks, no matter where you access Task Manager from

Task Grouping	Best Access Method
General tasks	Configure > Base Station > Task Manager
Tasks belonging to a channel profile	In the channel profile's Edit Channel Profile dialog box, select the Task Manager tab
Tasks belonging to a signalling profile	In the signalling profile's Edit Signalling Profile dialog box, select the Task Manager tab
Tasks that respond to an alarm	Configure > Alarms > Alarms Task Manager

Working With Task Manager

Task Manager forms let you work with the task list that the [Task Manager](#) processes. You can view the task list, add new tasks, modify existing ones, and rearrange the order and structure of tasks. Generally, a set of tasks is headed by a comment indicating their nature and purpose.

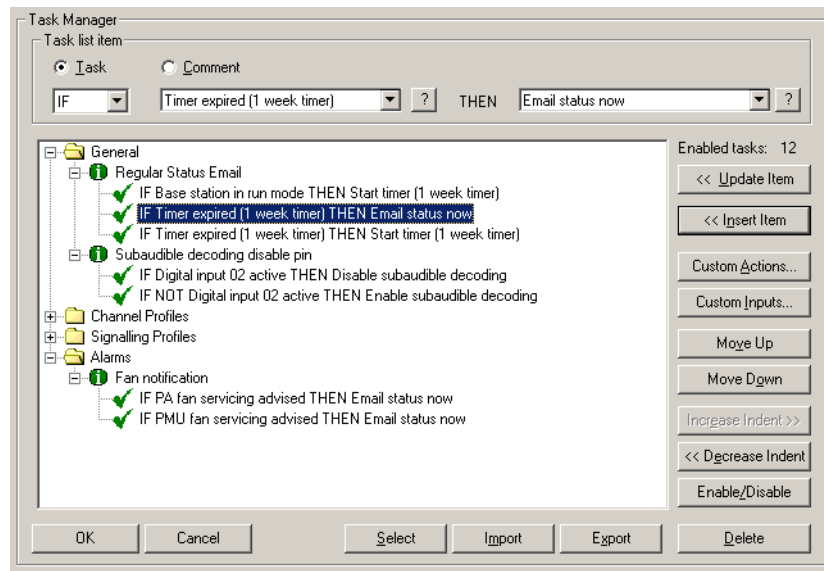

The **Task list item** area lets you edit a selected item, which can be a task or a comment. When a task is selected, you can click one of the special Help icons to display information about the task's input or action. The area also indicates the total number of enabled tasks.

The task list displays tasks in folders. Double-click a folder (or click its +/- icon) to open or close it. An open folder displays the tasks and comments that belong to it. Tasks generally have a tick; this means that they are enabled; tasks with a cross have been disabled. Click an item to select it; it appears inside the Task List Item area.

The folders group related tasks. Tasks in a folder for a particular profile (for example, the default channel profile, or Signalling profile 1) are only processed if the current channel uses that profile.

The buttons to the right lets you maintain the tasks in the list. For example, you can add an item or modify the selected item.

Maintaining the Task List

In Task Manager forms, the buttons to the right of the task list help you maintain the task list. To use some buttons, you must first select a task list item by clicking it.

- | | |
|---------------|---|
| <<Update Item | Saves changes you made to the selected item and updates the display in the Task List. |
| <<Insert Item | Inserts the task displayed in the Task list item area just below the selected item in the task list. See also “Adding a Task” on page 177 . |

Custom Actions	Opens the Custom Actions form, where you can define your own combination of existing actions.
Custom Inputs	Opens the Custom Inputs form, where you can define your own combination of existing inputs.
Move Up / Move Down	Shift the selected item up or down one line. Use these buttons to rearrange the order of tasks and comments in the task list.
Increase Indent / Decrease Indent	Let you add or remove an indent from a selected task. Indents have no effect on Task Manager processing; they help to make tasks easier to read and understand. You can only indent tasks that are under a comment.
Enable / Disable	By default, tasks are enabled; when an input condition becomes true, Task Manager processes the task. The Enable / Disable button lets you disable a task so that it has no effect, or toggle it between enabled and disabled. A standard base station can have up to 20 enabled tasks but up to 400 disabled ones.
Delete	The Delete button deletes the current task list item.

Adding a Task

To make full use of the base station’s capabilities, you need to add your own tasks to the list that Task Manager processes. This enables Task Manager to respond to events in a way that is tailored to your system. However, the set of actions must be well thought out to operate in exactly the way you want.



Important: It is possible to create tasks that undermine the base station’s ability to operate properly. Make sure that the choices you make are appropriate. Be particularly careful with powerful actions such as **Reset base station**.



Important: While Tait has carefully tested each input and each action, it is not possible to test the enormous number of possible combinations of inputs and actions. Thoroughly test any tasks you add before commissioning the base station. If you are uncertain about anything, refer to your supplier.

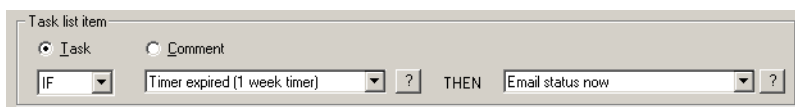

You can add a task anywhere in the task list. However, tasks in a channel profile or a signalling profile folder will only be actioned if the current channel has that profile assigned to it.

To define a task

1. Open a Task Manager form (see [“Accessing Task Manager”](#) on page 175).
2. If desired, click the folder you want the task to appear in.
3. Select **Task** in the Task list item area.
4. In the drop-down text box, select IF.

Alternatively, if you want the task to be processed when the input condition goes from true to false, select IF NOT. For example, tasks with the input

- 'IF NOT **Receiving valid signal**' will be processed when the base station stops receiving a signal with the correct subaudible signalling.
- Position the mouse cursor over the next drop-down box and right-click to open the list of available inputs. The inputs relevant to the context from which you accessed the Task Manager form appear in the main list; other inputs are grouped under headings.
 - Select an input from the list. It appears in the box.
 - In the same way, select an [action](#) from the drop-down list of the last drop-down text box.
 - In the task list, click a task to indicate where you want to add the task. Alternatively, click a folder.
 - Click <<**Insert Item**. The task appears in the task list.
 - If necessary, use the buttons on the right to move the task up or down, or to indent it.

Adding a Comment

When you define a set of tasks, you need to provide a comment that names them and indicates what they are for and how they work. You may also want to add further comments on individual tasks.

To add a comment

- Open a Task Manager form (see [“Accessing Task Manager” on page 175](#)).
- In the Task list item area, select the **Comment** option.
- Enter the text of the comment into the box below.
- Click <<**Insert Item**. The comment appears in the task list.
- If necessary, use the buttons on the right to move the comment up or down, or to indent tasks under it.
- Click **OK** to confirm your changes and close the form.

Disabling a Task

You can disable any task in the task list. This is an easy way to stop Task Manager doing something you don't want it to do. (When the base station is in Standby mode, Task Manager is disabled and no tasks are executed.)

To disable a task

- In any Task Manager form, click a task.
- Click **Enable/Disable**. The tick at the beginning of the task turns into a cross.

Importing Tasks

You can import a file containing tasks and comments that have been exported from another base station. Custom inputs or actions used by any of these tasks will also be imported.



Note: If an existing custom input or action has the same name as one to be imported, it will be overwritten without warning.

To import task items

1. In any Task Manager form, click **Import**.
2. Navigate to the folder containing the TB8100 task item export file (*.t8i), select it, and click **Open**.

Exporting Tasks

You can export tasks and comments to a file, which can be imported into other base stations.

To export task items

1. In any Task Manager form, click an item or a folder containing items, and click **Select**. The items turn bold. Repeat until you have selected everything you want to export.
2. Click **Export**. The Export Task Items dialog box appears.
3. Navigate to a suitable folder for the TB8100 task item export file (*.t8i) in, give the file a name and click **Save**.

Task Manager Inputs and Actions

Task Manager has a large set of inputs and actions.

To select an input or action

- Click in the appropriate box in the Task list item area. A menu with several submenus appears.

The menu shows you the input relevant to the context from which you accessed the Task Manager form. The submenus contain all the other inputs. You can select any input.

To obtain Help on a task's input or action

1. Click the task.
2. In the **Task list item** area, click the Help icon beside the appropriate box.

Inputs

An input is anything that Task Manager monitors. When the state of that input changes from false to true, Task Manager executes tasks with that input. IF NOT tasks are executed when the state of the input changes from true to false. Most inputs are set to true when the base station transitions to Run mode.

Many inputs read the state of a system flag. Select Monitor > Monitoring > Base Station to view the current state of system flags.

General Inputs

General inputs relate to the general operation of the base station.

Another receiver in rack

The **Another receiver in rack** input is true when there are two or more base stations in the BSS and they are responding to polls on the internal bus. This input is useful in combination with other inputs as a custom input.

Example

IF **Another receiver in rack** AND **Battery voltage low**
THEN **Go to channel 2**.

Another receiver in rack and **Battery voltage low** need to be combined as a custom input, and Channel 2 can be set up with an extra low power output.

This example could be used to provide an extra low power output when there are two base stations in the BSS. It could be used in a standard configuration used by all base stations in a system and would not be processed in single base stations.

Auxiliary supply enabled

The **Auxiliary supply enabled** input becomes true when Task Manager turns the Auxiliary supply flag on. If the Auxiliary power control box is set to Task Manager (Configure > Base Station > Miscellaneous), the auxiliary power output is active.

Base station in Run mode

The **Base station in Run mode** input becomes true when the base station goes into Run mode. This occurs on startup and when you tell a base station in Standby mode to change to Run mode.

Use this input for tasks you want included in Task Manager's initialization routine, to start timers, and to disable base station functions that you only want enabled under particular circumstances. You can also set a system flag to a value other than the usual default.



Important: The inverse of this input (IF NOT **Base station in Run mode**) must not be used; when the base station is not in Run mode, Task Manager is not operating.

Example

```
IF Base station in Run mode THEN Disable talk through repeater  
IF Base station in Run mode THEN Disable line controlled base station
```

This example could be used to configure a backup base station with everything disabled but ready to go into operation when needed.

Counter at maximum

The **Counter at maximum (Countername)** input becomes true when the particular named counter reaches the maximum value set for it in Configure > Task Manager > Counters.

The counter value changes through Task Manager actions such as **Increment counter**. Counter values are read at the beginning of a processing cycle. If the counter value changes during the processing cycle, it is immediately available; any subsequent tasks will use the new input. When the base station enters Run mode, all counters are reset to 0.

Example

```
IF Counter at maximum (LightTrigger) THEN Activate Digital Output 2.
```

See [“Base Station that Controls Landing Lights”](#) on page 201.

Flag set (flagname)

The **Flag set (flagname)** input becomes true when Task Manager sets the corresponding flag. Flagname represents any name that you assigned to the flag in Configure > Task Manager > Flags. The state of flags is read at the beginning of a processing cycle. If a flag state changes during the processing cycle, it is immediately available; any subsequent tasks will use the new input. When the base station enters Run mode, each flag is cleared, unless a Task Manager task explicitly sets it.

External channel select enabled

The override input **External channel select enabled** becomes true when Task Manager sets the H/W channel select flag. This occurs on entering Run mode and if a Task Manager task enables power saving after a previous task has disabled it.

Example

```
IF NOT External channel select enabled THEN Go to channel 2
```

This example specifies the channel that the TB8100 will operate on if a Task Manager action disables external channel selection. This is another way of specifying the channel in software; you can also select a channel as the default.

PA fan servicing advised

The **PA fan servicing advised** input becomes true when the PA fan operating time (Monitor > Data Logging > System Data) exceeds the hours in the **Operating time before servicing advised** box (Configure > Alarms > Thresholds).

Example

IF **PA fan servicing advised** THEN **Email status now**.

This can email the status message to the technician on duty. The status message indicates that the PA fan needs servicing.

PMU fan servicing advised

The **PMU fan servicing advised** input becomes true when the PMU fan operating time (Monitor > Data Logging > System data) exceeds the hours in the **Operating time before servicing advised** box (Configure > Alarms > Thresholds).

Example

IF **PMU fan servicing advised** THEN **Email status now**.

This can email the status message to the technician. The status message indicates that the PMU fan needs servicing.

Power saving enabled

The override input **Power saving enabled** becomes true when Task Manager turns the Power save system flag on. This occurs on entering Run mode and if a Task Manager task enables power saving after a previous task has disabled it.

Timer expired

A timer can only be started by the Task Manager action **Start timer**. It expires when the timer's maximum time has elapsed. This time was entered in Configure > Task Manager > Timers.

Example

IF Timer expired (**Weekly Email**) THEN **Email status now**.

This input can be used to set up regular actions such as emailing the status message.

Tx relay enabled

The override input Tx relay enabled becomes true when Task Manager turns the Tx relay system flag on. This occurs on entering Run mode and if a Task Manager task enables power saving after a previous task has disabled it.

Channel Profile Inputs

Channel profile inputs relate to configuration items that are defined in channel profiles. You can put tasks with a channel profile input into the folder for a particular channel profile or into the General folder. If the task is in a channel profile folder, it is only processed when the current channel uses that profile. If the task is in the General folder, it is always processed.

CWID enabled

The override input **CWID enabled** becomes true when Task Manager turns the CWID system flag on. This occurs on entering Run mode. It also occurs if a Task Manager task turns the flag on after a previous task has disabled it.

Intercom enabled

The override input **Intercom enabled** becomes true when Task Manager turns the Intercom system flag on. When the base station enters Run mode, Task Manager sets the Intercom system flag to off. When the **Intercom enabled** input is true, there is an audio path connecting the base station microphone and speaker to the audio in and out lines.

Line controlled base enabled

The override input **Line controlled base enabled** becomes true when Task Manager turns the Line connected base system flag on. This occurs on entering Run mode. It also occurs if a Task Manager task turns the flag on after a previous task has disabled it.

Loopback enabled

The override input **Loopback enabled** becomes true when Task Manager turns the Loopback system flag on. When the base station enters Run mode, Task Manager sets the Loopback system flag to off.

PA carrier present

Whenever the PA starts transmitting, the **PA carrier present** input is true. This input becomes true when the PA is keyed up.

PA keyed by Tx Key line

This input becomes true when the PA is keyed up to transmit as a line-controlled base station. This means that the Tx Key line has keyed up the PA and that it is the line in audio that will be transmitted.

PA keyed by valid Rx

This input becomes true when the PA is keyed up to transmit as a talk-through repeater. This means that the receiver has keyed up the PA and the received signal is being transmitted.

Receiver enabled

The override input **Receiver enabled** becomes true when Task Manager turns the Receiver system flag on. When the base station enters Run mode, Task Manager sets the Receiver system flag to on.

Receiving valid signal

The **Receiving valid signal** input becomes true when the conditions for opening the receiver gate are fulfilled. The received signal must meet the requirements for receiver gating defined in the current channel profile and for subaudible signalling defined in the current signalling profile. For example, the signal must be strong enough and use the right CTCSS tone.

When the base station receives a [valid signal](#), it does not necessarily make the Rx Gate line active.

IF NOT **Receiving valid signal** THEN **Transmit CWID now**.

This sends a Morse code identifier at the end of each transmission.

Rx Gate line active

The **Rx Gate line active** input becomes true when the Rx Gate line on the system interface goes low. This input is similar to **Receiving valid signal**, however the Rx Gate line becomes active not just when the base station is receiving a valid signal, but whenever there is a valid line audio output. This audio output can also come from the base station microphone or from line input (when loopback is enabled).



Note: If the current channel profile does not specify an audio path to line out, the Rx Gate line does not become active when a valid signal is being received.

Talk through repeater enabled

The override input **Talk through repeater enabled** becomes true when Task Manager turns the Talk through repeater system flag on. This occurs on entering Run mode. It also occurs if a Task Manager task turns the flag on after a previous task has disabled it.

Example

You could use this input as part of a set of tasks that impose a time limit on calls when in repeater mode.

IF **Talk through repeater enabled** AND **PA keyed by valid Rx**
THEN **Start timer (CallTimeLimit)**

The two inputs need to be combined into a custom input. When it becomes true, a timer is started. When this timer expires, other tasks can disable the repeater, start a timer for the transmit lockout, and re-enable the repeater.

Transmitter enabled

The override input **Transmitter enabled** becomes true when Task Manager turns the Transmitter system flag on. This occurs on entering Run mode. It also occurs if a Task Manager task turns the flag on after a previous task has disabled it.

Tx Key input enabled

The override input **Tx Key input enabled** becomes true when Task Manager turns the Tx Key system flag on. This occurs on entering Run mode. It also occurs if a Task Manager task turns the flag on after a previous task has disabled it.

Signalling Profile Inputs

Signalling profile inputs relate to configuration items that are defined in signalling profiles. You can put tasks with a signalling profile input into the folder for a particular signalling profile or into the General folder. If the task is in a signalling profile folder, it is only processed when the current channel uses that profile. If the task is in the General folder, it is always processed.

Subtone decoding enabled

The override input **Subtone decoding enabled** becomes true when Task Manager turns on the Subaudible decode system flag. This occurs on entering Run mode. It also occurs if a Task Manager task turns the flag on after a previous task has disabled it.

Subtone encoding enabled

The override input **Subtone encoding enabled** becomes true when Task Manager turns on the Subaudible encode system flag. This occurs on entering Run mode. It also occurs if a Task Manager task turns the flag on after a previous task has disabled it.

Tone nn detected

This input becomes true when the receiver detects a subaudible tone that is defined in the current signalling profile (Subaudible Signalling tab). *nn* refers to the number of the tone specified in that profile (a profile can have up to 16 tones defined).

Example

Enable the technician to request the emailing of a status message

IF Tone 2 detected THEN Email status now

When the base station receives the subaudible tone, the base station emails a status message. The signalling profile is set up so that this tone only results in Task Manager action. To obtain status information, the technician transmits that subaudible tone: Task Manager then instructs the base station to email the status message to the configured destination.

System I/O

System I/O inputs involve digital and audio inputs and outputs over the base station's system interface board.

Balanced input low

The **Balanced input low** input becomes true when the audio level on the unbalanced line falls below the minimum level specified in Configure > Alarms > Thresholds.

This input is useful in applications where the base station can expect a signal all the time. It lets you define tasks that specify actions when the expected audio input ceases.

Example

IF Balanced input low THEN Start over the air alarm

If the line fails, the base station sends alarm pips over the air.

Digital input active

The **Digital input active** input becomes true when the digital input becomes active.

Digital output nn active

The **Digital output nn active** input becomes true when the base station sets the digital output.

RSSI high

The **RSSI high** input becomes true when the RF signal that the base station is receiving exceeds the maximum signal strength specified in Configure > Alarms > Thresholds.

Example

IF **RSSI high** THEN **Go to channel 2**

Change to a channel with a lower output power on receiving a powerful signal.

RSSI low

The **RSSI low** input becomes true when the RF signal that the base station is receiving falls below the minimum signal strength specified in Configure > Alarms > Thresholds. This input is useful in applications where the base station can expect to be receiving a signal all the time. The input lets you specify what the base station is to do when the expected signal ceases.

Unbalanced input low

The **Unbalanced input low** Task Manager input becomes true when the audio input on the unbalanced line falls below the minimum level specified in Configure > Alarms > Thresholds. This Task Manager input is useful in applications where the base station can expect a signal all the time. The input then lets you define tasks that specify actions when the expected input ceases.

Example

Tell the base station to do something when the unbalanced line input signal fails.

IF **Unbalanced input low** THEN **Start over the air alarm**

If the line fails, the base station sends alarm pips over the air.

Alarm Inputs

You can select any alarm as a Task Manager input. This makes it possible to individually configure the base station's response to any alarm. For information about base station alarms, see [“Monitoring Alarms” on page 133](#). All alarms are basic inputs. Even if an alarm is disabled, tasks with that alarm as an input will be processed.

PA air intake temperature high

This input becomes true when the ‘Air intake temperature high’ alarm is triggered. For information about this alarm, see [“Air intake temperature high” on page 138](#).

PA air intake temperature low

This input becomes true when the ‘Air intake temperature low’ alarm is triggered. For information about this alarm, see [“Air intake temperature low” on page 138](#).

Base station alarm on

This input becomes true when any base station alarm is triggered.

Battery protection mode on

This input becomes true when the PMU is operating in battery protection mode, triggering the ‘Battery protection mode’ alarm. For information about this alarm, see [“Battery protection mode” on page 139](#).

Battery voltage high

This input becomes true when the ‘Battery voltage high’ alarm is triggered. For information about this alarm, see [“Battery voltage high” on page 139](#).

Battery voltage low

This input becomes true when the ‘Battery voltage low’ alarm is triggered. For information about this alarm, see [“Battery voltage low” on page 139](#).

Channel invalid

This input becomes true when the ‘Channel invalid’ alarm is triggered. For information about this alarm, see [“Channel invalid” on page 134](#).

Email service enabled

The **Email service enabled** input becomes true when Task Manager turns the Email alarms flag on. This occurs on entering Run mode. It also occurs if a Task Manager task turns the flag on after a previous task has disabled it.

External reference absent

This input becomes true when the ‘External reference absent’ alarm is triggered. For information about this alarm, see [“External reference absent” on page 138](#).

External reference invalid

This input becomes true when the ‘External reference invalid’ alarm is triggered. For information about this alarm, see [“External reference invalid” on page 138](#).

Fan failed

This input becomes true when the PA or PMU ‘Fan failed’ alarm is triggered. For information about these alarms, see [“Fan failed” on page 136](#) for the PA or [“Fan failure” on page 139](#) for the PMU.

Forward power low

This input becomes true when the ‘Forward power low’ alarm is triggered. For information about this alarm, see [“Forward power low” on page 136](#).

Mains supply failed

This input becomes true when the PMU’s ‘Mains supply failed’ alarm is triggered. For information about this alarm, see [“Mains supply failed” on page 139](#).

No PA detected

This input becomes true when the ‘No PA detected’ alarm is triggered. This occurs when the module fails or control bus communications are disrupted. For information about this alarm, see [“No PA detected” on page 135](#).

No PMU detected

This input becomes true when the ‘No PMU detected’ alarm is triggered. This occurs when the module fails or control bus communications are disrupted. For information about this alarm, see [“No PMU detected” on page 139](#).

Over the air alarm on

This input becomes true when Task Manager turns the over the air alarm on. For more information, see [“Over the air alarm actions” on page 197](#).

Over the line alarm on

This input becomes true when Task Manager turns the over the line alarm on. For more information, see [“Over the line alarm actions” on page 197](#).

PA alarm on

This input becomes true when any PA alarm is triggered.

PA current fault

This input becomes true when any of the PA’s current alarms are triggered. This happens if any part of the PA is drawing excessive current, or if one final stage uses significantly more current than the other. For information about these alarms, see [“Current” on page 137](#).

PA is shut down

This input becomes true when the PA’s ‘Shutdown’ alarm is triggered. For information about this alarm, see [“Shutdown” on page 136](#).

PA power foldback

This input becomes true when the PA’s ‘Power foldback’ alarm is triggered. For information about this alarm, see [“Power foldback” on page 136](#).

PA startup fault

This input becomes true when the ‘Hardware configuration invalid’ alarm or any of the ‘Calibration invalid’ alarms are triggered. For information about these alarms, see [“H/w configuration invalid” on page 136](#) and [“Calibration invalid” on page 136](#).

PA supply voltage fault

This input becomes true when one of the PA’s power supply voltage alarms is triggered. This happens if the voltage is too high or too low. For more information, see [“Supply voltage” on page 137](#).

PA temperature high

This input becomes true when the one or more of the PA’s ‘Temperature high’ alarms is triggered. For information about this alarm, see [“Temperature high” on page 137](#).

PMU alarm on

This input becomes true when any PMU alarm is triggered.

PMU output fault

This input becomes true when one of the PMU's output alarms is triggered, because the voltage is high or low or the current is high. For information about these alarms, see [“Output” on page 140](#).

PMU power up fault

This input becomes true when the PMU's 'Power up fault' alarm is triggered. For information about this alarm, see [“Power up fault” on page 139](#).

PMU shutdown imminent

This input becomes true when the PMU's 'Shutdown imminent' alarm is triggered. For information about this alarm, see [“Shutdown imminent” on page 139](#).

PMU temperature high

This input becomes true when the PMU's 'Temperature high' alarm is triggered. For information about this alarm, see [“Temperature high” on page 139](#).

Reciter alarm on

This input becomes true when any reciter alarm is triggered.

Reverse power high

This input becomes true when the 'Reverse power high' alarm is triggered. For information about this alarm, see [“Reverse power high” on page 136](#).



Note: Use the VSWR fault input instead of the Reverse power high input if the transmit power is set to less than 20 W or if the base station has a 5 W PA. The resolution of the reverse power measurement is 1 W; only a very serious antenna fault would trigger the reverse power high alarm if the power setting is low.

Synthesiser failed

This input becomes true when a synthesiser goes out of lock or the external frequency reference is invalid and the corresponding alarm is triggered. For information about these alarms, see [“Synthesiser out of lock” on page 135](#) and [“External reference invalid” on page 138](#).

VSWR fault

This input becomes true when the 'VSWR high' alarm is triggered. For information about this alarm, see [“VSWR high” on page 136](#).

Custom Inputs

The Custom Inputs submenu contains all the custom inputs that have been defined for the base station using [Configure > Task Manager > Custom Inputs](#).

Actions

An action is something that Task Manager instructs the base station to do.

There is often a group of actions relating to a particular base station function. For example, Task Manager can enable, disable, or toggle the talk through repeater function. Enable makes the function effective, disable makes it ineffective, and toggle changes from the one state to the other.



Tip: To obtain Help on a task's action, click the task. In the **Task list item** area, click the Help icon beside the action box.

General Actions

General actions relate to the general operation of the base station.

Auxiliary supply actions

Auxiliary supply actions can enable, disable, or toggle the auxiliary supply, provided that it is configured for Task Manager control. The Auxiliary power control box (Configure > Base Station > Auxiliary 2) must be set to Task Manager. Auxiliary supply actions affect the state of the Auxiliary supply system flag

Example

IF **Base station in Run mode** THEN **Enable auxiliary supply**

This task is used in TaitNet trunked networks to provide power to the trunking controller.

Fan test now

The 'do now' action **Fan test now** instructs the base station to run the fans for 5 seconds, irrespective of the temperature. If the fans are already running, this has no effect.

Email status

The 'do now' action **Email status** instructs the base station to email a status message via the Alarm Center, provided that an email service override action such as **Disable Email service** has not disabled this function. It sends the email according to the settings in Configure > Communications > Email. If necessary, the base station waits until the minimum interval between email notifications has elapsed before sending the status message. If more than one request is received before the minimum interval elapses, only one status message is sent.

Power saving actions

Power saving override actions can enable, disable, or toggle the power save system flag. When the base station enters Run mode, the flag is enabled.

When the power save flag is enabled, the power saving configuration in the current channel profile is effective. When it is disabled, there is no power saving.

Loopback actions

Loopback override actions can enable, disable, or toggle the Loopback system flag. When the base station enters Run mode, the flag is disabled.



Note: The default state of the Loopback system flag is 'disabled'. The default for most other system flags is 'enabled'.

For Loopback actions to have any real effect, corresponding audio paths (balanced in and balanced out, or unbalanced in and unbalanced out) must be configured in the current channel profile. If all four audio paths are enabled, there are two loopbacks; balanced audio in to balanced audio out, unbalanced audio in to unbalanced audio out).

When Loopback is enabled, corresponding input and output audio paths are connected to each other. A signal that is sent along the base station's line in is sent back down line out. This is useful for line testing.

When Loopback is disabled, there are no connections between input and output audio paths.

Example

IF Tone 15 detected THEN Enable loopback
IF Tone 16 detected THEN Disable loopback

You could use a single tone to toggle loopback, but this gives no certainty about the state of loopback.

Intercom actions

Intercom override actions can enable, disable, or toggle the Intercom system flag. When the base station enters Run mode, the flag is enabled.

For Intercom actions to have any real effect, corresponding audio paths must be configured in the current channel profile. This means that the base station microphone must be connected to the balanced and/or unbalanced line out. The speaker is always connected to the balanced line in.

When this system flag is disabled, the microphone's connections are disabled.

When this system flag is enabled, the audio path for the microphone and the speaker is as configured in the current channel profile's Signal Path tab.

Tx Key actions

The Tx Key system flag makes it possible for Task Manager to override the Tx Key line. Tx Key override actions can enable, disable, or toggle the flag. When the base station enters Run mode, the flag is enabled.

When the Tx Key system flag is disabled, the transmitter does not key up when the Tx Key line on the system interface goes active.

When the Tx Key system flag is enabled, the transmitter keys up when the Tx Key line on the system interface goes active and transmits the audio provided to it on the balanced and/or unbalanced line in.

The Tx Key system flag has no effect on the base station's internal keying logic.

Reset base station

The 'do now' action **Reset base station** resets the base station. You can use this action in tasks designed to help the base station recover from minor faults.



Note: When a base station is reset, it reverts to its default channel.

Example

IF Tone 2 detected THEN Reset base station

This task means that a technician can remotely reset the base station by sending a radio signal with the appropriate subaudible signalling.

Transmitter actions

Transmitter override actions can enable, disable, or toggle the Transmitter system flag. This provides you with an additional layer of control over transmitter operation.

When the base station enters Run mode, the flag is enabled.

When the Transmitter system flag is disabled, the transmitter cannot transmit.

When the Transmitter system flag is enabled, the transmitter operates as usual.

If the PMU is fitted with a standby converter and the Receiver and the Transmitter system flags are both disabled, the PMU shuts down as in Deep Sleep mode.



Note: You can shut down specific forms of the transmitter operation. See [“Talk Through Repeater Actions” on page 193](#) and [“Line-Controlled Base Actions” on page 194](#).

Receiver actions

Receiver override actions can enable, disable, or toggle the Receiver system flag. This provides you with an additional layer of control over receiver operation.

When the base station enters Run mode, the flag is enabled.

When the Receiver system flag is disabled, the receiver cannot receive.

When the Receiver system flag is enabled, the receiver operates as configured.

If the PMU is fitted with a standby converter and the Receiver and the Transmitter system flags are both disabled, the PMU shuts down as in Deep Sleep mode.

External channel select actions

External channel select override actions can enable, disable, or toggle the H/W channel select system flag. This provides you with an additional layer of control over how the current channel is selected.

When the base station enters Run mode, the flag is enabled.

When the flag is disabled, the channel is specified in software (Configure > Base Station > General). The base station uses the default channel.

When the flag is enabled, the channel is specified by the Channel select lines connected to the system interface card. The system interface must be configured using the Service Kit to enable channel selection.



Note: Other Task Manager actions can tell the base station to change to a different channel.

Start timer

Task Manager can start or stop any of its 16 timers. When a timer is started, it is re-initialised, then it begins to count down, beginning at the time set in Configure > Task Manager > Counters and Timers. When it has counted down to zero, it expires. You can create tasks that are executed when a timer expires.

Stop timer

Task Manager can start or stop any of its 16 timers. When a timer is stopped, it ceases to count down, so it does not expire. If it is re-started, it starts counting down again from the length of time set in Configure > Task Manager > Counters and Timers. You can create tasks that are executed when a timer expires.

Set flag

Task Manager can set or clear any of 16 numbered flags. A flag can only have one of two states: set or cleared. The state of a flag can be used as an input in other tasks.

Clear flag

Task Manager can set or clear any of 16 numbered flags. A flag can only have one of two states: set or cleared. The state of a flag can be used as an input in other tasks.

Increment counter

The Increment counter action adds one to the counter specified. When a counter reaches its specified maximum, it triggers actions with the input **Counter at maximum**.

Reset counter

The Reset counter action sets the value of the counter specified to zero, so that it must begin counting anew.

Decrement counter

The Decrement counter action subtracts one from the current value of the counter specified.

Channel Profile Actions

Channel profile actions relate to configuration items that are defined in channel profiles. You can put tasks with a channel profile action into the folder for a particular channel profile or into the General folder. If the task is in a channel profile folder, it is only processed when the current channel uses that profile. If the task is in the General folder, it is always processed.

Talk Through Repeater Actions

Talk through repeater override actions can enable, disable, or toggle the Talk through repeater system flag. This gives you an extra layer of control over the audio path that feeds received audio into the transmitter. It lets you program the base station to operate as a talk through repeater in some situations, and to intelligently switch to another way of operating when the situation changes.

When the base station enters Run mode, the flag is enabled.

When the flag is disabled, the base station cannot function as a talk through repeater. Any internal audio path joining receiver and transmitter is disconnected and receiving a valid signal does not key the transmitter.

When the flag is enabled, the internal audio path is as configured in the channel profile.

If the channel profile does not configure the base station as a talk through repeater, these Task Manager actions have no effect.

Line-Controlled Base Actions

Line-controlled base override actions can enable, disable, or toggle the Line controlled base system flag. This gives you an extra layer of control over the audio path that feeds line in audio into the transmitter. It lets you program the base station to operate as a line-controlled base station in some situations, and to intelligently switch to another way of operating when the situation changes.

When the base station enters Run mode, the flag is enabled.

When the flag is disabled, the base station cannot function as a line-controlled base station. The Tx Key line and any internal audio path joining a line input to the transmitter are disconnected.

When the flag is enabled, the internal audio path is defined by the channel profile and the Tx Key line can be used to key the transmitter.

If the channel profile does not configure the base station as a line-controlled base station, these Task Manager actions have no effect.

Go to channel

The **Go to channel** action instructs the base station to change channel and operate according to the configuration defined by the channel with the number specified in the action. It stays on that channel until another Task Manager action changes channel or a reset returns it to the default channel.

In base stations with a complex set of Task Manager tasks, you need to understand exactly how this action works. It is not a ‘do now’ action; the actual change of operating channel happens at the end of a processing cycle. This means, for example, that if the task list has a **Go to channel 5** action followed by a **Go to channel 6** action, the base station will only ever change to channel 6.



Note: Hardware channel selection overrides all Task Manager channel actions.

Make current channel the default

The **Make current channel the default** action instructs the base station to select the channel it is currently operating on as the default channel. This action is the equivalent of selecting the channel in Configure > Base Station > General, and programming the base station with that change. If Task Manager changes to a new channel and makes that channel the default, the base station stays on that channel even after a reset.

In base stations with a complex set of Task Manager tasks, you need to understand exactly how this action works. The action takes what Task Manager views as the current channel. For example, a base station is operating on Channel 1 and the task list has a **Go to channel 5** action followed by a **Make current channel the default** action, and then a **Go to channel 6** action. The result of processing this list is that channel 5 is the default. It is not Channel 1 (the current channel during the processing cycle) or channel 6 (the channel that the base station goes to at the end of the processing cycle).



Note: Hardware channel selection overrides all Task Manager channel actions.

Go to next channel

The **Go to next channel** action instructs the base station to operate on the next valid channel in the channel table. If the base station was on Channel 001, it changes to Channel 002. It stays on that channel until Task Manager changes channel or a reset returns it to the default channel.

In base stations with a complex set of Task Manager tasks, you need to understand exactly how this action works. It is not a ‘do now’ action; the actual change of operating channel happens at the end of a processing cycle. This means, for example, that if the task list has two **Go to next channel** actions, the base station will move two channels down the channel table.



Note: Hardware channel selection overrides all Task Manager channel actions.

CWID Actions

Task Manager can enable, disable, or toggle the CWID system flag. This provides you with an additional layer of control over the transmission of a [CWID](#).

When the base station enters Run mode, the flag is enabled.

When the flag is disabled, there is no automatic transmission of the CWID.

When the flag is enabled, CWID is transmitted as configured in the channel profile’s CWID System tab.

If the channel profile does not provide for CWID, this flag has no effect.

Transmit CWID now

The ‘do now’ action **Transmit CWID now** instructs the base station to immediately transmit the CWID message defined in the CWID System tab. [This](#) action enables you to configure CWID transmissions in a way that is not otherwise possible. For example, you could have the CWID transmitted more than once a minute or at every transmit tail.

Transmit CWID now works even if a CWID action has disabled the CWID system flag.

Power saving actions

Power saving override actions can enable, disable, or toggle the Power save system flag. This provides you with an additional layer of control over power saving.

When the base station enters Run mode, the flag is enabled.

When the flag is disabled, no power saving occurs.

When the flag is enabled, power saving occurs as specified in the Power Saving tab of the Channel profile.

Signalling Profile Actions

Signalling profile actions relate to configuration items that are defined in signalling profiles. You can put tasks with a signalling profile action into the folder for a particular signalling profile, or into the General folder. If the task is in a signalling profile folder, it is only processed when the current channel uses that profile. If the task is in the General folder, it is always processed.

Subaudible Decoding

Subaudible decoding override actions can enable, disable, or toggle the Subaudible decode system flag. This gives you an extra layer of control over the base station's response to subaudible signalling.

When the base station enters Run mode, the flag is enabled.

When the flag is enabled, any subtones are decoded and checked against the current signalling profile. A received signal is only valid if it contains a specified subtone.

When the flag is disabled, subaudible signalling is not decoded. The received signal is regarded as valid irrespective of its subaudible signalling.

Subaudible Encoding

Subaudible encoding override actions can enable, disable, or toggle the Subaudible encode system flag. This gives you an extra layer of control over the subaudible signalling that the base station encodes onto its transmissions.

When the base station enters Run mode, the flag is enabled.

When the flag is enabled, the base station encodes transmissions according to the signalling profile's configuration (Subaudible signalling tab).

When the flag is disabled, transmissions are not encoded with subaudible signalling.

System I/O

System I/O actions affect the base station's digital outputs.

Activate Digital Output n

The **Activate Digital Output n** action makes the Digital Out n line on the system interface **active**. If this line does not exist on the current user interface, the action has no effect.

In base stations with a complex set of Task Manager tasks, you need to understand exactly how this action works. The actual activation of the digital output doesn't happen till the end of a processing cycle. So the task list can activate and deactivate a digital output many times, but the output line will only ever be activated if the last action for that digital output is to activate it.

IF Counter at maximum (LightTrigger) THEN Activate Digital Output 2.

See [“Base Station that Controls Landing Lights”](#) on page 201.

Deactivate Digital Output n

The **Deactivate Digital Output n** action makes the Digital Out n line on the system interface **inactive**. If this line does not exist on the current user interface, the action has no effect.

In base stations with a complex set of Task Manager tasks, you need to understand exactly how this action works. The actual deactivation of the digital output doesn't happen till the end of a processing cycle. So the task list can activate and deactivate a digital output many times, but the output line will only ever be deactivated if the last action for that digital output is to deactivate it.

Tx Relay actions

Tx relay override actions can enable, disable, or toggle the Tx Relay system flag. This gives you an additional layer of control over the Tx Relay Driver line on the system interface. When the base station enters Run mode, the flag is enabled.

When the Tx Relay system flag is disabled, the Tx Relay Driver line cannot go active.

When the Tx Relay system flag is enabled, the base station can control an antenna relay using the Tx Relay Driver line, switching the relay before powering its transmitter up.

If the base station is not fitted with a system interface board that provides a Tx Relay Driver line, the Tx Key system flag has no effect.

Alarm

Alarm actions make it possible for you to configure the way that the base station responds to alarm conditions.

Over the air alarm actions

Over the air alarm actions can turn the base station's over the air alarm on or off. Indeed, Task Manager action is the only way that this alarm can be started or stopped.

When the base station enters Run mode, Task Manager ensures that the over the air alarm is turned off.

When Task Manager turns on the over the air alarm, the base station starts transmitting the alarm over the air according to Configure > Alarms > Notification Methods.

When Task Manager turns off the over the air alarm, the base station stops transmitting the alarm.

Over the line alarm actions

Over the line alarm actions can turn the base station's over the line alarm on or off. Indeed, Task Manager action is the only way that this alarm can be started or stopped.

When the base station enters Run mode, Task Manager ensures that the over the line alarm is turned off.

When Task Manager turns on the over the line alarm, the base station starts sending the alarm over the line according to Configure > Alarms > Notification Methods. It will be sent over audio out lines that the system interface provides and that are enabled in the current channel profile's audio path.

When Task Manager turns off the over the air alarm, the base station stops sending the alarm.

Email status now

The 'do now' action **Email status now** turns on a flag requesting that the base station email the status message. The email will be sent via an Alarm Center according to the configuration in Configure > Communications > Email.



Note: A status message can only be sent once the minimum interval has elapsed after the last status message or alarm log was sent. This avoids (for example) receiving an email every time the base station keys up.



Note: Task Manager can disable the email service, which will override any future **Email status now** action. See [“Email service actions” on page 198](#).

Clear alarm log

The ‘do now’ action **Clear alarm log** empties the alarm log of all entries. This can be a useful action after the alarm log has been sent. Although Alarm Center will not duplicate alarms in its display, clearing the alarm log reduces the communications load involved in sending the alarm log.

Example

IF Timer expired (**Email Timer**) THEN **Clear alarm log**

This task could be part of a set of tasks that emails the alarm log once per day. When a day timer expires, the alarm log is emailed. The email timer gives the base station time to send the alarm log. When that timer expires, the action clears the log, so that alarms are not sent more than once.

Email service actions

Task Manager can enable, disable, or toggle the Email system flag. This gives you an extra layer of control over the base station’s emailing functions.

When the base station enters Run mode, the flag is enabled.

When the flag is enabled, Task Manager can email status messages (see [“Email status now” on page 197](#)). The base station does this according to the configuration in Configure > Communications > Email.

When the flag is disabled, any **Email status now** actions are disregarded.

Send alarm log now

The **Send alarm log now** action sends the alarm log to an Alarm Center, according to the configuration in Configure > Communications > Alarm Center. This configuration must have enabled Alarm notification to the Alarm Center, or the action has no effect.

First, the base station attempts to connect to the Alarm Center and log on. If it is successful, the base station sends its name and the contents of the alarm log, and then logs off and disconnects.

Example

IF **Base station in Run mode** THEN **Start timer (24 hour Timer)**

IF Timer expired (**24 hour Timer**) THEN **Send alarm log now**

IF Timer expired (**24 hour Timer**) THEN **Start timer (24 hour Timer)**

Custom Actions

The Custom Actions submenu contains all the custom actions that have been defined for the base station using Configure > Task Manager > Custom Actions.

Task Manager Examples

Task Manager makes it possible for you to build complex functions into the base station. Here are some examples of to give you an idea of what can be done.



Important: While Tait has carefully tested Task Manager, no guarantee can be given that these examples will work correctly for your system. Make sure that you thoroughly test any set of Task Manager tasks before commissioning the system.

Repeater Changeover

A line-controlled base station is connected to a console that provides tone on idle. The following Task Manager tasks automatically convert the TB8100 to a talk-through repeater if the line fails. When the line is re-established, the TB8100 reverts to line-controlled operation.

IF Base station in Run mode THEN Disable talk through repeater.

This disables the base station's talk through repeater mode whenever it enters Run mode.

IF Balanced input low THEN Enable talk through repeater.

IF Balanced input low THEN Disable line-controlled base station.

IF Balanced input low THEN Start over the air alarm.

If the line fails, the input line level falls below the prescribed minimum. This triggers Task Manager actions that switch off the line-controlled base station mode, enable the talk through repeater mode, and start sending alarm pips over the air.

IF NOT Balanced input low THEN Disable talk through repeater.

IF NOT Balanced input low THEN Enable line-controlled base station.

IF NOT Balanced input low THEN Stop over the air alarm.

When the line is re-established, Task Manager actions re-establish the line-controlled base station function and stop the alarm.

Data and Speech Service

A repeater needs to relay speech as well as data. The speech needs to be pre-emphasised while the data needs the full band from < 50 Hz to 3000 Hz. Speech is sent with a CTCSS tone.

The base station needs to be able to automatically change between repeating pre-emphasised audio and repeating full band audio.

To achieve this, follow these steps:

1. Set up Channel 1 as a speech repeater. The channel profile (Signal Path tab) is set to De-emph Speech Band / Pre-emph Speech Band.
2. Set up Channel 2 as a data repeater. The channel profile (Signal Path tab) is set to Flat Full Band.
3. Set Timer 1 to 150 milliseconds, corresponding to the time that the base station needs to decode subaudible signalling.

4. Create two custom inputs:
 - Data Chan Detected**, which consists of Timer 1 expired AND Tone 1 NOT detected.
 - Speech Chan Detected**, which consists of Timer 1 expired AND Tone 1 detected.
5. Create the following Task Manager tasks for Channel 1:
 - IF Receiving valid signal THEN Start timer 1.**
 - IF NOT Receiving valid signal THEN Stop timer 1.**
 - IF Data Chan Detected THEN Go to channel 002.**

Receiving a valid signal on Channel 1 starts a timer. If no subaudible signalling is detected when the timer expires, the custom input Data Channel Detected becomes true and Task Manager instructs the base station to go to channel 002.
6. Create the following Task Manager tasks for Channel 2
 - IF Receiving valid signal THEN Start timer 1.**
 - IF NOT Receiving valid signal THEN Stop timer 1.**
 - IF Speech Chan Detected THEN Go to channel 001.**

Receiving a valid signal on Channel 2 starts a timer. If subaudible signalling is detected before the timer expires, the custom input Speech Channel Detected becomes true and Task Manager instructs the base station to go to channel 001.

Base Station with Automatic Charging

If the battery voltage goes low, the base station operates on lower power, starts the generator and sends transmitter pips. As soon as the battery voltage is back to normal, transmitter power is increased. The generator continues for one hour (or until a high battery voltage alarm is triggered). This ensures that the battery is properly charged.

To set this up, follow these steps:

1. Set up Channel 1 at 100 watts for mains power and 60 watts for battery power.
2. Set up Channel 2 as a low battery channel, with only 25 watts output power.
3. Set up Timer 1 as Generator On timer with a duration of one hour.
4. Set up a custom action End of Charging with the following actions:
 - Deactivate Digital Output #1 AND**
 - Stop timer #1 (Generator On timer)**
 - Stop over the air alarm**
5. Set up the following Task Manager tasks:
 - IF Battery voltage low THEN Go to channel 002**
 - IF NOT Battery voltage low THEN Go to channel 001.**

When the battery voltage is low, this switches operation to Channel 002, which has a reduced PA output power.

 - IF Battery voltage low THEN Activate Digital Output #1.**
 - IF Battery voltage low THEN Start over the air alarm**
 - IF Battery voltage low THEN Start timer #1.**

When the battery voltage is low, a digital output is set, which starts the generator. Additional actions turn on over the air pips and start a timer that will turn the generator off.

IF *Battery voltage high* THEN *End of Charging*

IF *Timer #1 expired* THEN *End of Charging*

These two tasks stop the generator when the battery voltage gets too high or when the Generator On time expires.

Base Station with Auxiliary Antenna

You can set up a base station with an auxiliary antenna and use Task Manager actions to automatically switch to that antenna when there is an antenna mismatch. The service person can use a radio to send CTCSS tone 2 to switch the antenna back.

IF *Base station in Run mode* THEN *Deactivate Digital Output 2*

This sets the antenna relay at power up.

IF *VSWR fault* THEN *Activate Digital Output 5*

IF *VSWR fault* THEN *Email status now*

If a VSWR fault occurs, Task Manager automatically swaps the antenna over and emails the alarm log.

IF *Tone 02 detected* THEN *Deactivate Digital Output 5*

To switch the antenna back, the technician transmits a signal with CTCSS tone 2.

Base Station Regularly Emails its Status

It is straightforward to use Task Manager tasks to have the base station email its status to the maintenance technician, for example, once a week.

To do this, you define a timer with a one week duration. When the timer expires, the status is emailed and the timer re-started.

IF *Base station in Run mode* THEN *Start timer (1 week timer)*

IF *Timer expired (1 week timer)* THEN *Email status*

IF *Timer expired (1 week timer)* THEN *Start timer (1 week timer)*

This combination of tasks emails the status of the base station once a week.

Base Station that Controls Landing Lights

A small private airport does not have full time air traffic control. When landing at night, the pilot needs to switch on the runway lights. Pilots have VHF radios without CTCSS, Selcall, or any other signalling. The pilot presses PTT three times within two seconds to switch on the lights.

1. Wire Digital Output #6 to control the lights.
2. Give Counter #1 a maximum of 3.
3. Give Timer #1 a maximum of 2 seconds.
4. Give Timer #2 a maximum of 30 minutes
5. Set up the following Task Manager tasks:

IF *Receiving valid signal* THEN *Start timer (Timer 1)*

IF *Receiving valid signal* THEN *Increment counter (Counter 1)*

IF *Timer expired (Timer 1)* THEN *Reset counter (Counter 1)*

This set of tasks detects three presses of PTT, provided they occur before Timer #1 expires.

IF Counter at maximum (Counter 1) THEN Start timer (Timer 2)
IF Counter at maximum (Counter 1) THEN Activate Digital Output 6
IF Counter at maximum (Counter 1) THEN Reset counter (Counter 1)

This set of tasks starts the lights timer, turns the lights on, and re-starts the counter for detecting three presses of PTT.

IF Timer expired (Timer 2) THEN Deactivate Digital Output 6

This task turns the lights off when the 30 minutes has elapsed.

Scanning Repeater

In a two-repeater site, Task Manager makes it possible for either repeater to turn into a scanning repeater if the other repeater fails. The scanning repeater handles both channels, providing a complete backup system.

When a repeater fails, the other starts scanning. It changes to a channel, waits a few 100 ms, checks the received signal, and, if nothing is there, it goes to the next channel. If there is a signal, it will just repeat it as usual, complete with all the signalling and line output requirements for that channel. Here a single base station is providing the same service but with a poorer throughput.

IF Base station in Run mode THEN Start timer (ChangeChannel)
IF Receiving valid signal THEN Stop timer (ChangeChannel)
IF Receiving valid signal THEN Stop timer (On Channel)
IF NOT Receiving valid signal THEN Start timer (On Channel)
IF Timer expired (ChangeChannel) THEN Go to next channel
IF Timer expired (ChangeChannel) THEN Start timer (ChangeChannel)
IF Timer expired (On Channel) THEN Go to next channel
IF Timer expired (On Channel) THEN Start timer (ChangeChannel)

This example is a straightforward scanner. It will search through all the channels in the channel table looking for activity. A small variation on this can make it stay on its home channel until an external signal triggers the scanning.

Digital Inputs with Special Functions

Task Manager tasks make it possible for digital inputs to have a great variety of functions.

Subtone Decode Disable Pin

When digital input # is active, the base station disables the decoding of subaudible signalling.

IF Digital input # active THEN Disable subaudible decoding
IF NOT Digital input # active THEN Enable subaudible decoding

Cancel Alarms Pin

When the digital input is activated, Task Manager action ceases to dial up an Alarm Center to send alarm logs and status messages.

IF Digital input # active THEN Disable alarm service
IF NOT Digital input # active THEN Enable alarm service

Customizing Task Manager

Customizing Task Manager adds to its power and flexibility. There are several options available. You can create custom inputs or actions and define timers, counters, and flags. You can then use them to create tasks that will be executed when the custom input becomes true, the timer expires, the counter reaches its maximum, or the flag is activated.

Working With Custom Inputs

The Custom Inputs form (Configure > Task Manager > Custom Inputs) lets you work with custom inputs. It lists the existing custom inputs and lets you see what combination of standard inputs each consists of. You can also create new custom inputs and edit or rename existing ones.

A custom input is a user-defined Task Manager input that consists of a combination of standard inputs. Custom inputs make it possible to define tasks that will be processed when a combination of inputs becomes true. (A Task Manager task can only have one input.)

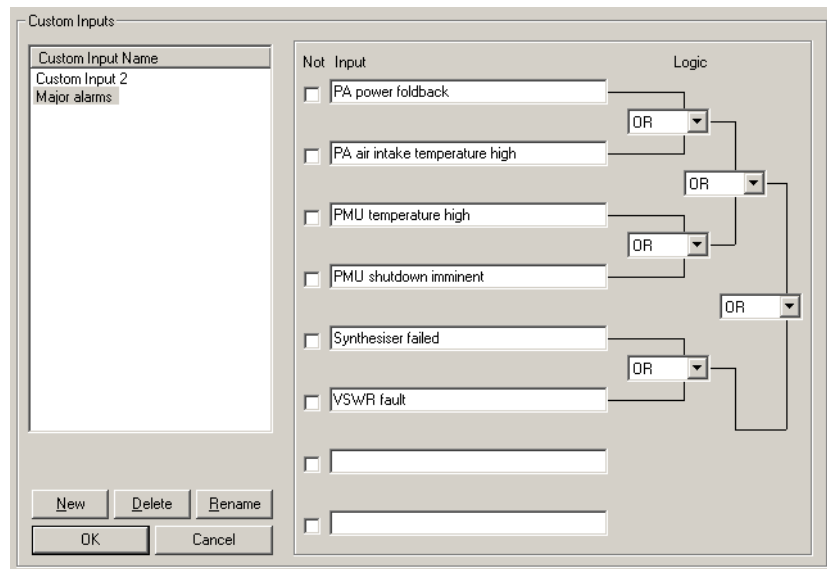

Viewing a Custom Input

1. Click an item in the Custom Input Name column.
2. View the display in the rest of the form. It shows the standard inputs used to create the custom input, whether they are negated, and the logic of their combination. The standard truth table determines the outcome for the different states of any pair. (See [“Truth Table” on page 204.](#))

The Logic column shows graphically how the standard inputs will be combined. First the input is negated, if its Not check box is selected. Then it is combined with the adjacent input to which it is joined by a line. The result of that combinatorial operation is combined with the input or result that it is joined to, and so on, until the final result is obtained. In this way, up to eight standard inputs can be combined to produce an input that can only be true or false.

Defining a Custom Input

1. Click **New**.
2. Edit the name that appears in the Custom Input Name column.
3. Click in an **Input** box and select an input from the list.
4. If you want the negative of the input to contribute to the custom input's logic, select the **Not** check box alongside.
5. Repeat steps 3 and 4 for all the standard inputs that will go to make up the custom input. The Input boxes that you choose will determine the order in which the standard inputs are combined.
6. Under the **Logic** heading, select the appropriate options in the drop-down boxes to give the logical combination of inputs that you want. (For information about the effect of the different options, see [“Truth Table” on page 204.](#))
7. Click **OK**.

Truth Table

The truth table below displays the possible individual values for input A and input B, and the result when you combine those values using each of the six available logic operators. So, for example, if A is true and B is false and we combine A and B using XOR, the result is true.

A	B	AND	NAND	XOR	XNOR	OR	NOR
false	false	false	true	false	true	false	true
false	true	false	true	true	false	true	false
true	false	false	true	true	false	true	false
true	true	true	false	false	true	true	false

Working With Custom Actions

The Custom Actions form (Configure > Task Manager > Custom Actions) lets you work with custom actions. It displays the list of existing custom actions. If you select a custom action, it displays the set of standard actions that it consists of. You can also create new custom actions and edit or rename existing ones.

A custom action is a user-defined Task Manager action that consists of more than one standard action. It saves you writing several different tasks with the same input.

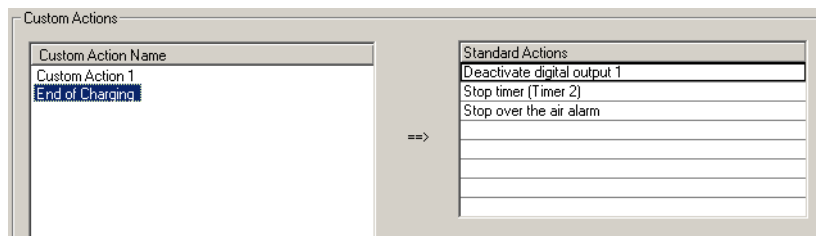

Viewing a Custom Action

1. Click an item in the Custom Action Name column.
2. View the Standard Actions column. It lists the standard actions that the custom action consists of.

Defining a Custom Action

1. Click **New**.
2. Edit the name that appears in the Custom Action Name column.
3. Click in the first row of the Standard Actions column and select an action from the list.
4. Repeat step 3 for all the standard actions that will go to make up the custom action.
5. Click **OK**.

Defining Counters, Timers, and Flags

Counters, timers, and flags make it possible for Task Manager to do such things as respond to three presses of PTT or to email a status message once a week.



Note: Short timers may not be accurate. This is because it may take Task Manager longer than 10 ms to process its tasks, causing it to miss the next instruction to go through its task list. Tait recommends that you avoid short timers (< 50 ms) if the task list has more than 10 enabled tasks.

To define a counter

1. Select Configure > Task Manager > Counters.
2. If desired, enter a suitable name for the counter into the **Name** box.
3. In the **Maximum** box, enter the highest number that the counter can reach.

When the counter reaches its maximum, the input **Counter at maximum** becomes true for that counter and any tasks containing it are processed.

To define a timer

1. Select Configure > Task Manager > Timers.
2. If desired, enter a suitable name for the timer into the **Name** box..
3. In the **Maximum** box, enter the highest number that the timer can reach.
4. In the **Units** box, specify what unit of time the number you entered represents.

When the timer reaches its maximum, the input **Timer expired** becomes true for that timer and any tasks containing it are processed.

To define a flag

1. Select Configure > Task Manager > Flags.
2. If desired, enter a suitable name for the flag into the **Name** box.
3. Click **OK**.

Monitoring Task Manager

The items under Monitor > Task Manager provide options for monitoring Task Manager. If the base station is behaving unexpectedly, you can view the state of system flags to see whether Task Manager has overridden the normal configuration. Alternatively, open the Recent Actions form to see a list of actions that Task Manager has recently carried out. You also can view the current state of timers, counter, and flags.

Viewing System Flag States

The System Flags form (Monitor > Task Manager > System Flags) displays the current state of flags that Task Manager sets in the base station firmware. A green LED means that the flag is enabled. A gray LED means that it is disabled. Most flags are enabled by default, but **Loopback**, **Over the air alarms**, and **Over the line alarms** are disabled. When the base station enters or re-enters Run mode, Task Manager sets all flags to their default values. Flags only change when Task Manager executes a task that enables, disables, or toggles them.



Important: The System Flags area shows you the state of the flags, not necessarily the state of the corresponding base station function. It is important to understand this distinction. For example, if the **Loopback** flag is enabled, the base station's audio will in fact be looped back only if the current [channel profile](#) provides compatible line in and line out audio paths. If the **Email alarms** flag is enabled, the base station will only actually email alarms if email alarm notification is enabled and correctly configured in Configure > Communications > Email.

Use the System Flags area to find out whether Task Manager has enabled or disabled any functions. If a system flag does not show the default setting, Task Manager has changed it. Checking the state of the [alarm notification](#) functions is particularly important.

The System Flags area is an important place to check, if the base station is not behaving as expected; [Task Manager actions](#) may be responsible.

Loopback	When the Loopback flag is enabled, audio from the line input is connected directly to line output. Loopback can only happen if the current channel profile's signal path has a line input and a line output. A balanced input can only be looped back to a balanced output and an unbalanced input can only be looped back to an unbalanced output. By default, the flag is disabled.
Intercom	When the Intercom flag is enabled, a technician at the base station can communicate with a console over the line. The Base Station's microphone is connected to line output. When the flag is disabled, the microphone is disconnected, but the speaker still remains connected to the receiver Path A.
Tx Key	When the Tx Key flag is enabled, the Tx Key line on the system interface can be used to key up the transmitter. When the flag is disabled, you can still transmit microphone audio using the PTT key, but the Tx Key line has no effect, which means that line audio is not transmitted.
Receiver	When the Receiver flag is enabled, the receiver is able to receive as usual, according to the current channel configuration. When the flag is disabled, the receiver is unable to pass any received audio.

Transmitter	When the Transmitter flag is enabled, the transmitter is able to transmit as usual, according to the current channel configuration. When the flag is disabled, the transmitter is unable to transmit signal at all.
Talk through repeater	When the Talk through repeater flag is enabled, the base station feeds received audio into the transmitter according to the current channel profile. (Edit Channel Profile form: Audio Path tab. The Talk-through repeater box specifies the audio path.) When the flag is disabled, the transmitter is not given audio from the receiver.
Line connected base	When the Line connected base flag is enabled, the base station feeds line in audio into the transmitter according to the current channel profile. (Edit Channel Profile form: Audio Path tab. The Tx audio path A or Tx audio path A check box must be selected.) When the flag is disabled, the transmitter is not given line in audio.
Power save	When the Power save flag is enabled, the base station applies power saving according to the current channel profile (Edit Channel Profile form: General tab). When the flag is disabled, power saving is not applied.
Auxiliary supply	When the Auxiliary supply flag is enabled, the auxiliary power output is turned on, if the optional auxiliary power supply PCB is fitted to the PMU, and if it is configured to be under the control of Task Manager (Configure > Base Station > Miscellaneous, Auxiliary power control box). If the Auxiliary supply flag is disabled, the auxiliary power is turned off, unless it is configured for battery charging (on when the mains supply is on).
Over the air alarm	When the Over the air alarm flag is enabled, an alarm is sent over the air according to the configuration in Configure > Alarms > Notification Methods: Over the air notification area. When the flag is disabled, the over the air alarm is turned off.
Over the line alarm	When the Over the line alarm flag is enabled, an alarm is sent over the line according to the configuration in Configure > Alarms > Notification Methods: Over the line notification area. When the flag is disabled, the over the line alarm is turned off.
Email service	When the Email alarms flag is enabled, any alarms are sent via email according to the configuration in Configure > Communications > Email. When it is disabled, alarms are not sent via email.
CWID	When the CWID flag is enabled, the base station transmits a continuous wave ID (Morse code) according to the current channel profile (Edit Channel Profile form: CWID System tab). When the flag is disabled, no Morse code is transmitted.
Subaudible encode	When the Subaudible encode flag is enabled, the base station encodes audio according to the current signalling profile (Edit Signalling Profile form: Subaudible signalling tab). When the flag is disabled, subaudible signalling is not added to audio.

Subaudible decode	When the Subaudible decode flag is enabled, the base station decodes any subaudible signalling according to the current signalling profile (Edit Signalling Profile form: Subaudible signalling tab). When the flag is disabled, subaudible signalling is not decoded, which means that there is no receiver gating based on subaudible signalling.
H/W channel select	When the H/W channel select flag is enabled, the base station uses the channel number specified by external equipment. This equipment sets the channel number using channel selection lines on the system interface (see Configure > Base Station > System Interface. The Channel selection check box must be enabled.) When the flag is disabled, the base station uses the default channel (set in Configure > Base Station > General) or a channel specified by Task Manager action.
Tx Relay	When the Tx Relay flag is enabled in a simplex system, the base station can use the Tx Relay Driver line on its system interface to switch a relay that connects the transmitter or the receiver to the antenna. When Tx Relay is disabled, the Tx Relay Driver line has no effect.

Monitoring Recent Actions

The **Recent Actions** form displays the last 40 tasks that Task Manager carried out. This display shows you the situation when you opened the form: the display does not automatically update.



Note: To see the current state of many parameters that Task Manager monitors, select Monitor > Task Manager > System Flags. These flags have a default state and are only altered when Task Manager executes a task.

To monitor recent Task Manager actions

1. Select Monitor > Task Manager > Recent Actions.
2. If you want to update the display, click **Read Last 40 Statements**. Statements (actions) executed after you opened the form are added to the display.

Viewing Timers

The Timers form (Monitor > Task Manager > Timers) displays the current state of any timers that you configured for Task Manager.

The Name column lists the timers. A bar graph shows how far each timer has progressed towards its maximum value, which is displayed in the Maximum column.

Viewing Counters

The Counters form (Monitor > Task Manager > Timers) displays the current state of any counters that you configured for Task Manager.

The Name column lists the counters. A bar graph shows how far each counter has progressed towards its maximum value, which is displayed in the Maximum column.

Viewing Flag States

The Flags form (Monitor > Task Manager > Timers) displays the current state of any custom flags that you configured for Task Manager.

Each of the possible flags has an LED alongside it. A Green LED means that the timer is set. A gray LED means that it is cleared.

Glossary

This glossary contains an alphabetical list of terms and abbreviations related to the TB8100 base station. For information about trunking, mobile, or portable terms, consult the glossary provided with the relevant documentation.

A

- access level** There are three different levels of access to a base station: Administrator, User, and Read-only. The User access level has a configurable access profile; the Administrator decides which functions that access level can carry out.
- action** An action is the second part of a Task Manager task. It specifies what the base station must do when the first part (the input) becomes true.
- active** Digital outputs are active when the base station pulls their voltage low and current is flowing. Digital inputs are active when external equipment is pulling them to ground. All base station digital inputs and outputs are open collector.
- ADC** Analog-to-Digital Converter. A device for converting an analog signal to a digital signal that represents the same information.
- Alarm log** The alarm log is a list of the last 50 alarms that the base station generated. This list is stored in the base station. To view it, select Monitor > Alarms > Reported Alarms.
- Alarm Center** Alarm Center is a utility provided with the Service Kit that is able to receive, store, and display alarms from any number of base stations with dial-up connections. Participating base stations need an Alarm Reporting license. Alarm Center also routes emailed messages to the email server.
- alarm notification** Alarm notification is the process by which the base station passes on information about an alarm condition. It can notify alarms over the air, over the line, via email, or to an Alarm Center. It can also activate a digital output. If the Service Kit is logged on to the base station, it is automatically notified of any alarms.

air intake temperature

The temperature of the air as measured at the PA's air intake.

anti-kerchunking

Anti-kerchunking is a base station configuration that discourages users from kerchunking.

B

balanced line

A balanced line has two wires carrying equal and opposite signals. It is typically used in a line-connected base station for connecting to the despatcher console. The system interface identifies the balanced line in as Rx+ and Rx-, and the balanced line out as Tx+ and Tx-.

BCD

BCD (binary coded decimal) is a code in which a string of four binary digits represents a decimal number.

BSS

A BSS (base station system) is a subrack containing at least one TB8100 base station.

C

Calibration Kit

The TB8100 Calibration Kit is a utility for defining the switching ranges of the receiver and the exciter and for flattening the receiver response across its switching range. It can also be used to calibrate various parts of the reciter and the PA circuitry.

CCDI2

CCDI2 (computer controlled data interface version 2) is a proprietary Tait command protocol used between computer equipment and a Tait radio.

channel

A channel is:

1. A frequency pair (or just a single frequency in a simplex system).
2. A set of configuration information that defines the frequency pair and other settings. Also referred to as a channel configuration. Generally, 'channel' has this meaning in the Service Kit.

channel profile	A channel profile is a named set of configuration items relating to the base station's RF configuration, transmitter power output and power saving modes. Like the signalling profile, it can be applied to any channel. Together, these profiles define most configuration items.
channel spacing	Channel spacing is the bandwidth that a channel nominally occupies. If a base station has a channel spacing of 12.5 kHz, there must be a separation of at least 12.5 kHz between its operating frequencies and those of any other equipment.
channel table	The channel table is the base station's database of channel configurations. To view it, select Configure > Base Station > Channel Table.
CODEC	An IC which combines analog-to-digital conversion (coding) and digital-to-analog conversion (decoding).
configuration file	A configuration file consists of all the configuration settings needed for a base station, stored as a file in the configurations folder. Configuration files have the extension *.t8c.
connection	A connection is a named group of settings that the Service Kit uses when establishing communications with a BSS.
control bus	The control bus is used for communications between modules in a base station system. It is an I2C bus, a bi-directional two-wire serial bus which is used to connect integrated circuits (ICs). I2C is a multi-master bus, which means that multiple chips can be connected to the same bus, and each one can act as a master by initiating a data transfer.
control panel	The control panel is an area at the front of the BSS with buttons, LEDs and other controls that let you interact with the BSS.
CTCSS	CTCSS (continuous tone controlled squelch system), also known as PL (private line) is a type of signalling that uses subaudible tones to segregate groups of users.
custom action	A custom action is a user-defined Task Manager action that consists of more than one pre-defined action.
custom input	A custom input is a user-defined Task Manager input that consists of a combination of pre-defined inputs.

CWID	CWID (Continuous W ave I Dentification) is a method of automatically identifying the base station using a Morse code. Continuous wave means transmission of a signal with a single frequency that is either on or off, as opposed to a modulated carrier.
D	
DAC	Digital-to-Analog Converter. A device for converting a digital signal to an analog signal that represents the same information.
DCS	DCS (digital coded squelch), also known as DPL (digital private line), is a type of subaudible signalling used for segregating groups of users. DCS codes are identified by a three-digit octal number, which forms part of the continuously repeating codeword. When assigning DCS signalling for a channel, you specify the three-digit code.
de-emphasis	De-emphasis is a process in the receiver that restores pre-emphasised audio to its original relative proportions.
duty cycle	Duty cycle is used in relation to the PA. It is the proportion of time (expressed as a percentage) during which the PA is operated. The TB8100 PA can be operated continuously.
E	
EIA	Electronic Industries Alliance. Accredited by the American National Standards Institute (ANSI) and responsible for developing telecommunications and electronics standards in the USA.
EMC	Electromagnetic Compatibility. The ability of equipment to operate in its electromagnetic environment without creating interference with other devices.
ETSI	European Telecommunications Standards Institute. The non-profit organisation responsible for producing European telecommunications standards.

F

- flag** A flag is a programming term for a “yes/no” indicator used to represent the current status of something. The base station has a set of system flags that are read and set by Task Manager. There is also a separate set of flags that you can use in your own Task Manager tasks.
- frequency band** The range of frequencies that the equipment is capable of operating on.
- front panel** The cover over the front of the BSS containing fans for the PA and PMU.

G

- gating** Gating is the process of opening and closing the receiver gate. When a valid signal is received, the receiver gate opens.

H

- hiccup mode** Many power supplies switch off in the event of a short-circuit and try to start again after a short time (usually after a few seconds). This “hiccup”-type of switching off and on is repeated until the problem is eliminated.
- hysteresis** Hysteresis is the difference between the upper and lower trigger points. For example, the receiver gate opens when the upper trigger point is reached, but will not close until the level falls to the lower trigger point. An adequate hysteresis prevents the receiver gate from repeatedly opening and closing when the level is about that of the trigger point.
- Hysteresis mode** A mode of PMU operation designed to save power. The PMU is mainly turned off, but switches back on intermittently to maintain output voltage when the output current is low.

I

inactive Digital outputs are inactive if the base station is doing nothing to them. They are floating, open collector outputs. Digital inputs are inactive when they are open circuit.

Intercom mode Intercom mode makes it possible for the operator at the dispatch center and the servicing technician at the base station to communicate with each other over the line. It connects the base station microphone to line out.

isolator An isolator is a passive two-port device which transmits power in one direction, and absorbs power in the other direction. It is used in a PA to prevent damage to the RF circuitry from high reverse power.

K

kerchunking Kerchunking is transmitting for a second or less without saying anything in order to test the base station. This results in a 'kerchunk' sound.

L

line-controlled base station A TB8100 is a line-controlled base station when it receives audio (sending it out via its systems interface), transmits audio received over its systems interface, and its transmitter is keyed via the Tx Key line.

logging on Once you are connected to a BSS, you log on to a base station. This establishes communications between the Service Kit and a particular base station.

N

navigation pane The navigation pane is the left-hand pane of the Service Kit application window. It displays a hierarchical list of items. When you click an item, the main pane displays the corresponding form.

O

operating range Operating range is another term for switching range.

P

PA The PA (power amplifier) is a base station module that boosts the exciter output to transmit level.

PMU The PMU (power management unit) is a module that provides power to the BSS.

pre-emphasis Pre-emphasis is a process in the transmitter that boosts higher audio frequencies.

R

reciter The reciter is a module of a TB8100 base station that acts as receiver and exciter.

reverse tone burst Reverse tone bursts can be used with CTCSS. When reverse tone bursts are enabled, the phase of the generated tones is reversed for a number of cycles just before transmission ceases. If the receiver is configured for reverse tone burst, it responds by closing its gate.

RSSI RSSI (Received Signal Strength Indicator) is a level in dBm or volts that indicates the strength of the received signal.

Run mode Run mode is the normal operating mode of the base station.

signalling profile A signalling profile is a named set of configuration items related to signalling that can be applied to any channel. Items include subaudible signalling and transmit timers.

S

sensitivity The sensitivity of a radio receiver is the minimum input signal strength required to provide a useable signal.

SINAD	SINAD (Signal plus Noise and Distortion) is a measure of signal quality. It is the ratio of (signal + noise + distortion) to (noise + distortion). A SINAD of 12 dB corresponds to a signal to noise ratio of 4:1. The TB8100 can provide an approximate SINAD value while in service by comparing the in-band audio against out-of-band noise. This value should not be relied upon to make calibrated measurements.
Sleep mode	Sleep mode is a power saving state in which a part of the base station is switched off, and then periodically switched on again.
Standby mode	Standby mode is a mode of base station operation in which active service is suspended so that special operations can be carried out, such as programming the base station with a new configuration.
status message	A status message is a set of information about the base station that can be emailed. It identifies the base station, indicates the current operating channel, lists the status of all alarms, and gives the current values of a number of other monitored parameters. It also contains the alarm log.
subaudible signalling	Subaudible signalling is signalling that is at the bottom end of the range of audible frequencies. The TB8100 base station supports CTCSS and DCS subaudible signalling.
subtone	A subtone (subaudible signalling tone) is a CTCSS tone or a DCS code.
switching range	The switching range is the range of frequencies (about 10 MHz) that the equipment is tuned to operate on. This is a subset of the equipment's frequency band.
system flag	System flags are binary indicators that are read and set by Task Manager. Generally, they are used to disable or enable configured base station functions.
system interface	The system interface is the set of inputs to and outputs from the base station (excluding power and RF), provided by a board inside the reciter. A range of different boards are available for different applications.

T

- TB8100 Base Station** A Tait TB8100 base station consists of the equipment necessary to receive and transmit on one channel. Generally, this means a reciter, a PA, and a PMU. Often abbreviated to TB8100 or base station.
- Talk Through Repeater** A TB8100 is a talk through repeater when its audio path is configured to pass the audio it receives on to the transmitter.
- Task Manager** Task Manager is a part of the TB8100 base station firmware that carries out tasks in response to inputs. These tasks are formulated using the Service Kit.
- template file** A template file contains configuration information that can be used to create a new base station configuration. Template files have the extension *.t8t.
- transmit lockout** The transmit lockout feature prevents the base station from transmitting for a time once the transmit timer has expired. It is designed to prevent users from monopolizing the base station.

U

- Unbalanced line** An unbalanced line has one wire earthed. It is typically used for short connections, for example, between a base station and a repeater on the same site. The system interface identifies the wires of unbalanced lines with Rx audio, Tx audio, and Audio Ground. Audio Ground is common to line in and line out.

V

- valid signal** A valid signal is a signal that the receiver responds to by opening the receiver gate. A signal is valid for example when it is stronger than a minimum level and when it has the specified subtone.
- VSWR** Voltage Standing Wave Ratio (VSWR) is the ratio of the maximum peak voltage anywhere on the line to the minimum value anywhere on the line. A perfectly matched line has a VSWR of 1:1. A high ratio indicates that the antenna subsystem is poorly matched.

W

Watchdog

A watchdog circuit checks that the system is still responding. If the system does not respond (because the firmware has locked up), the circuit resets the system.

Index

A

- access level [40](#)
- access profile [47](#)
- AC-DC converter [62, 68](#)
- actions (Task Manager) [189](#)
 - alarm [197](#)
 - channel profile [193](#)
 - custom [198](#)
 - general [190](#)
 - signalling profile [195](#)
 - System I/O [196](#)
- Add Channel Profile dialog box, accessing [94](#)
- Administrator access level [40](#)
- advanced profile features [93](#)
- Advanced Profiles and Task Manager license [15, 93](#)
- air intake temperature [66](#)
- alarm [13, 131](#)
 - adjusting thresholds [143](#)
 - configuring for fan [82](#)
 - disabling [142](#)
 - emailing [149](#)
 - flashing icon [20](#)
 - list of recent [141](#)
 - monitoring [133](#)
 - monitoring from Service Kit [20](#)
 - notification methods [145](#)
 - notifying Alarm Center [147](#)
 - over the air [145](#)
 - over the line [146](#)
 - polling interval [35](#)
 - reported alarms [141](#)
 - Task Manager actions [197](#)
 - Task Manager inputs [186](#)
 - turning over-the-air alarm on and off [197](#)
 - turning the over-the-line alarm on and off [197](#)
 - using CWID as [110](#)
 - using pip tone as [145](#)
- Alarm Center [12](#)
 - sending alarms to [147](#)
- alarm log [141](#)
 - clearing (by Task Manager action) [198](#)
 - saving to file [141](#)
 - sending (by Task Manager action) [198](#)
- alarm notification [13](#)
 - setting up [13](#)
- Alarm Reporting license [15](#)

- Alarm status LED [60](#)
- antenna relay [83](#)
- antenna, automatic switching of (Task Manager code) [201](#)
- anti-kerchunking [118](#)
- application window [31](#)
- audio filter [105](#)
- audio input
 - measuring level of [159](#)
 - monitoring [65](#)
 - monitoring level of [65](#)
 - summing from line and receiver [104](#)
- audio output
 - configuring line level [105](#)
 - generating [160](#)
 - monitoring [65](#)
 - monitoring level of [65](#)
- audio path [103](#)
- automatic gain control [100](#)
- auxiliary power output
 - availability of [62](#)
 - configuring [84](#)
 - monitoring state of [69](#)
 - testing [170](#)

B

- balanced line
 - measuring level of [159](#)
- bandwidth [124](#)
- base station
 - naming [76](#)
 - operation mode [4](#)
 - programming [44](#)
 - resetting [41](#)
 - resetting (by Task Manager action) [191](#)
 - self-tests [154](#)
 - testing [151](#)
 - upgrading firmware [52](#)
- base station system
 - connecting to [38](#)
- basic tasks [29](#)
- battery
 - automatic charging of (Task Manager code) [200](#)
 - configuring minimum voltage [84](#)
 - state of [68](#)
- battery backup
 - testing [169](#)

- battery charger
 - configuring auxiliary power as 84
 - monitoring state of 69
- battery protection mode 139
- battery voltage
 - monitoring 67
 - system data on 71
- BCD format 78
- BSS
 - connecting to 38
- Bypass checkbox 105, 108

C

- calibration
 - date of 60
- Carrier gating 100
- carrier, maximum frequency deviation 85
- Celsius 33
- channel 5
 - adding 126
 - block copying 126
 - configuring 87
 - configuring for TaitNet 90
 - copying 126
 - defining a set of 89
 - editing (when custom profiles are used) 125
 - exporting 127
 - getting started 89
 - importing 127
 - profiles assigned to 63
 - selecting (by Task Manager action) 194
 - selecting default 76
 - selecting default (by Task Manager action) 194
 - selecting externally 77
 - selecting one to operate on 128
 - setting up 89
 - source of channel selection 64
- Channel Guard see subaudible signalling
- channel profile
 - adding 94
 - customizing the default 90
 - editing 97
 - list of 94
 - naming 98
 - Task Manager actions for 193
 - working with 94
- channel spacing 124
 - of receiver 98
 - when block copying 126
- channel table 5, 122
 - arrow in 122
 - working with 122
- clock reference, source of 64
- coded squelch see DCS code
- comment, in Task Manager 178
- compatibility file 52
- configuration
 - creating 43
 - creating template from 45
 - file location 33
 - handling of older versions 51
 - printing 86
 - programming base station with 44
 - reading 43
 - saving to file 44
 - tutorial 24
 - viewing 22
 - ways of working with 42
- connecting
 - directly 38
 - remotely 12
- connection 34
 - adding 34
 - dial-up 35
 - direct 34
 - displayed in status bar 32
 - editing 37
 - intermittent 35
 - over-the-air 36
 - slow 35
 - types of 34
 - using USB instead of a serial port 34
- control panel
 - status of power supply to 68
 - testing 155
 - testing LEDs 155
- counter
 - defining 205
 - Task Manager action 193
 - viewing 208
- CTCSS 7
 - decode speed 120
 - decoding reverse tone burst 120
 - detect bandwidth 85
 - detection time 85
 - gating options 120
 - reject bandwidth 85
 - setting deviation of 99
- CTCSS characteristics 85
- current channel 5
 - details of 63
- Current Status form 133
- custom action 11, 204
 - defining 205

- viewing 205
- custom input 11, 203
 - defining 204
 - viewing 203
- custom profile 93
 - See channel profile and signalling profile
- CWID 110
 - automatic transmission of 110
 - disabling (by Task Manager action) 195
 - transmitting (by Task Manager action) 195

D

- dBm, converting to microvolts 80
- DC-DC converter 62, 68
- DCS code 7
 - matching base station's code to radios' code 7
 - setting deviation of 99
- DCS end tone 119
- Decode signal column 116
- de-emphasis 105
- Deep Sleep mode 8, 109
- default channel 5
 - selecting 76
 - setting 128
- default channel profile 90
- default profile 6
- Default Radio System license 15
- default signalling profile 92
- Delay before relay opens box 83
- diagnosing 23
 - how to 153
 - overview 151
- dial-up connection 35
- digital input
 - assigning function to (Task Manager code) 202
 - viewing state of 161
- digital output
 - activating (Task Manager action) 196
 - deactivating (Task Manager action) 196
 - toggling 161
 - viewing status of 161
- Digital Private Line see DCS code 7
- direct connection 34
 - access profile for 47
- disconnecting 49
- do now action 11
- Download mode 4
 - selecting 41
- duty cycle
 - average over life of base station 70

- monitoring 66

E

- email 149
 - automatic sending of (Task Manager code) 201
 - disabling (by Task Manager) 198
 - sending (Task Manager action) 190
 - testing 163
- enabling additional features 54
- exciter, switching range of 59
- external channel selection 77
 - disabling 78
 - disabling (by Task Manager action) 192
 - testing 162
- external reference
 - alarm 138
 - specifying frequency of 85

F

- Fahrenheit 33
- fan
 - alarms 82
 - emulating T800 81
 - monitoring operating hours 82
 - operating time (PA) 71
 - operating time (PMU) 71
 - rotation detector 82
 - testing 165, 166, 169
 - testing (Task Manager action) 190
- fault diagnosis 23
- feature enabler 15
- feature set
 - disabling 55
- filter
 - bypassing 105, 108
 - on audio path 105
- firmware
 - downgrading 52
 - folder for upgrade files 33
 - upgrading 52
- flag
 - defining 205
 - viewing 208
- form 31
- forward power 66

G

- gating, of receiver 96

getting started [17](#)

H

hang time [119](#)

hardware channel selection [77](#)
testing [162](#)

heatsink temperature
of PA [165](#)
of PMU [171](#)

hysteresis, in receiver gating [101](#)

I

idle time [97](#)

IF and IF NOT tasks [10](#)

inputs (Task Manager) [180](#)

alarm [186](#)

custom [203](#)

for channel profile [183](#)

for signalling profile [185](#)

for system I/O [185](#)

general [180](#)

installation [24](#)

intercom mode, disabling (by Task Manager action) [191](#)

interface See system interface board

isolator [61](#)

K

kerchunking [118](#)

keyup time
configuring [110](#)

L

license file, folder to store in [33](#)

license key [54](#)

line in

setting expected level [108](#)

line level

of input [108](#)

setting for line out [105](#)

line-controlled base station, disabling (by Task Manager action) [194](#)

local connection See direct connection

lock range

determining [158](#)

lockout

of transmitter [118](#)

log files, location of [33](#)

logging off [49](#)

logging on [39](#)

loopback, enabling (Task Manager action) [190](#)

low current option [8](#)

M

mains supply, state of [68](#)

Max Tx deviation box [99](#)

microphone

testing microphone channel switch [155](#)

testing PTT operation [155](#)

microvolts, converting to dBm [80](#)

mid band [98, 124](#)

mode [4](#)

changing [41](#)

viewing current [32](#)

monitoring [21, 57](#)

operational information [63](#)

PA [66](#)

PMU [67](#)

polling interval [35](#)

reciter [65](#)

subaudible signalling [164](#)

Morse code [110](#)

multiple

in Channel Profiles form [94](#)

in channel table [122](#)

N

naming the base station [76](#)

narrow band [98, 124](#)

navigation pane [21, 31](#)

red item in [153](#)

Noise gating [100](#)

Normal power saving mode [8, 109](#)

O

operating channel [128](#)

operating time [70](#)

operation mode [4](#)

output current [69](#)

over the air alarm

turning on and off [197](#)

over the line alarm

turning on and off [197](#)

Override actions (Task Manager) [10](#)

P

PA

- alarm status [135](#)
 - fan operating time [71, 71](#)
 - monitoring air intake temperature [66](#)
 - monitoring duty cycle [66](#)
 - monitoring operational information on [66](#)
 - monitoring temperature of [66, 165](#)
 - not detected [135](#)
 - power rating [61](#)
 - state of power supply to [68](#)
 - testing fault LED [165](#)
 - version [61](#)
 - viewing information on [60](#)
- password [40](#)
- changing [46](#)
- Permanent option button [70](#)
- PGM800Win, comparing Service Kit with [3](#)
- pip tone
- over the air [145](#)
 - over the line [146](#)
- PMU
- alarm status [139](#)
 - auxiliary power output [84](#)
 - available inputs [62](#)
 - available outputs [62](#)
 - configuring shutdown voltage [84](#)
 - monitoring heatsink temperatures [171](#)
 - monitoring operational information on [67](#)
 - monitoring output current [69](#)
 - monitoring output voltage [171](#)
 - product code [61](#)
 - serial number [62](#)
 - submodules in [62](#)
 - testing [169](#)
 - testing fault LED [170](#)
 - version [62](#)
 - viewing information on [61](#)
- polling interval [35](#)
- power output
- monitoring [66](#)
 - of PA [66](#)
 - setting [95, 100](#)
 - to PA [68](#)
 - to reciter [68](#)
- power saving [8](#)
- configuring [96, 109](#)
 - disabling (by Task Manager action) [195](#)
 - effect on quality of service [8](#)
 - overriding (by Task Manager action) [190](#)
- Power Saving Modes license [15](#)
- Power shutdown voltage box [84](#)
- Power startup voltage box [84](#)

- pre-emphasis [105](#)
- printing a configuration [86](#)
- Private Line see CTCSS tone
- profile [6](#)
 - advanced features of [93](#)
- programming base station [44](#)

Q

- quality of service [8](#)
- Quasi Synch mode [85](#)

R

- Read icon [43](#)
- Read only access level [40](#)
- receiver
- audio path [104](#)
 - disabling (by Task Manager action) [192](#)
 - idle time [97](#)
 - lock range [158](#)
 - measuring received signal level [157](#)
 - operating without a configuration [156](#)
 - switching range [59](#)
 - testing [156](#)
- Receiver channel box [98, 99](#)
- receiver gating [100](#)
- configuring [96](#)
- receiver sensitivity
- AGC affects [100](#)
 - testing [157](#)
- receiver squelch [100](#)
- reciter
- alarm status [134](#)
 - lock range [158](#)
 - monitoring operational information on [65](#)
 - serial number of [60](#)
 - state of power supply to [68](#)
 - testing [156](#)
 - version [60](#)
 - viewing information on [59](#)
- Relay closing settling time box [83](#)
- relay line [83](#)
- reminder tone [114, 121](#)
- enabling [117](#)
- remote connection [12](#)
- access profile for [47](#)
- repeater
- for speech and data (Task Manager code) [199](#)
 - setting gain of [99](#)
- repeater changeover (Task Manager code) [199](#)
- reported alarms [141](#)

- Reported Alarms form 141
 - resets, number of 71
 - Resettable option button 70
 - resetting the base station 41
 - reverse power 66
 - reverse tone burst 119, 120
 - decoding 120
 - RF power output
 - setting 95, 100
 - RSSI
 - alarm 138
 - monitoring 65
 - system data on 71
 - RSSI gating 100
 - RSSI output
 - configuring 78
 - setting a voltage 163
 - testing 162
 - Run mode 4
 - automatically reverting to 85
 - Rx cycling 97, 109
 - Rx Gate output
 - toggleing 161
 - viewing status of 65, 161
- S**
- scanning repeater (Task Manager code) 202
 - See channel table, entry in profile dialog box 90
 - self-tests 154
 - sensitivity of receiver 157
 - serial port 35, 37
 - USB to serial converter 34
 - Service Kit
 - application window 31
 - installing 24
 - monitoring alarms 20
 - number of resets 71
 - signal level
 - measuring across band 157
 - signal path 103
 - signalling profile
 - adding 112
 - customising the default 92
 - editing 115
 - list of 112
 - Task Manager actions 195
 - Task Manager inputs 185
 - working with 112
 - simulcast
 - configuring base station for 85
 - SINAD
 - measurement method 156
 - monitoring 65
 - SINAD gating 100
 - Sleep mode 8, 109
 - Soft-off time 120
 - software feature enabler 15, 54
 - speaker, testing 155
 - speech band filter 105
 - squelch See receiver gating
 - squelch tail 118
 - Standby converter
 - state of DC supply to 68
 - Standby mode 4
 - Start after box 97, 110
 - status bar 32
 - subaudible band filter 105
 - Subaudible deviation 99
 - subaudible signalling 7
 - disabling decoding of (Task Manager action) 196
 - disabling encoding of (Task Manager action) 196
 - monitoring 164
 - Subaudible Signalling tab 115
 - subtone 7
 - encoding options 117
 - specifying the ones to recognize 116
 - switching range 59
 - exciter 59
 - when last altered 60
 - synthesiser
 - alarm 135
 - determining lock range 158
 - out of lock 135
 - system alarms 137
 - system data 70
 - system flags 206
 - system I/O
 - Task Manager actions 196
 - system interface 14
 - system interface board 77
 - configuring for external channel selection 77
 - installed version 59
 - pin assignments on 77
 - viewing details of 77
- T**
- T800, comparing TB8100 with 3
 - tail timers 118
 - TaitNet
 - configuring for 90, 105, 108

- talk through repeater
 - disabling 193
- Talk through repeater box 106
- talk through repeater gain 99
- task
 - adding 177
 - disabling 178
 - exporting 179
 - importing 179
- Task Manager 9, 173
 - accessing 175
 - actions 10
 - adding comments 178
 - adding tasks 177
 - custom actions 198
 - customizing 203
 - disabling tasks 178
 - example tasks 199
 - exporting tasks 179
 - flags 206
 - importing tasks 179
 - input types 10
 - inputs 180
 - monitoring recent actions 208
 - number of resets 71
 - tasks 10
 - working with 176
- temperature
 - Celsius or Fahrenheit 33
 - monitoring on PA 66, 165
 - monitoring on PMU 171
 - system data on 71
- template 45
- test tone, generating 160
- testing 23
 - audio output 160
 - auxiliary power output 170
 - battery backup 169
 - control panel 155
 - digital I/O 160
 - email 163
 - external channel selection 162
 - fan 165, 166, 169
 - I/O 159
 - lock range 158
 - PA 165
 - PA fault LED 165
 - PMU 169
 - PMU fault LED 170
 - receiver sensitivity 157
 - RSSI output 162
 - transmitter 166
- Thresholds form 143
- timer
 - defining (Task Manager) 205
 - starting (by Task Manager action) 192
 - stopping (by Task Manager action) 193
 - viewing 208
- toolbar 31
- traffic light 4, 41
- transmit lockout 118
- transmit timers 118
- transmitter
 - configuring audio path for 107
 - disabling (by Task Manager action) 192
 - keying sources 103
 - power output 66
 - setting keyup time 110
 - summing audio from line and receiver 104
 - testing 166
- transmitter power output 100
 - setting 95
- troubleshooting
 - PC to base station communications 35
- truth table 204
- tutorial 24
- Tx Key input
 - disabling (by Task Manager action) 191
 - viewing status of 65
- Tx keyup time 97, 110
- Tx max deviation 124
- Tx relay 83
 - disabling (by Task Manager action) 197
- Type box 77

U

- unbalanced line
 - measuring level of 159
 - monitoring 65
- Untitled.t8c file 43, 44
- upgrading
 - base station firmware 52
- USB port 34
- User access level 40
 - configuring profile of 47

V

- version number
 - of PA 61
 - of PMU 62
 - of reciter 60
- Vpp, of line in 108
- VSWR
 - monitoring 66

system data on [71](#)

W

watchdog resets [71](#)

wide band [98](#), [124](#)